

Spectral Sub-Surface Scattering (S^4) for material classification

ECCV 2024

Haejoon Lee and Aswin Sankaranarayanan

Carnegie
Mellon
University

Motivation



Motivation

Motivation Imaging Experiment

Plastic



Jade

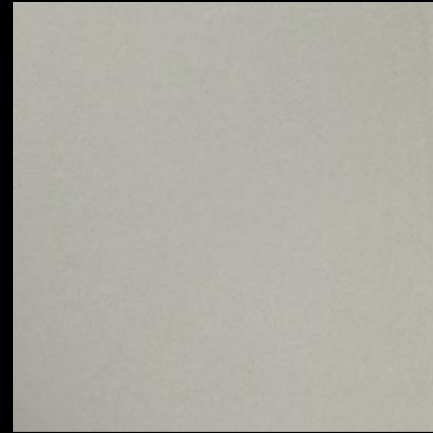

Wax



Copy paper



Motivation

Spectral analysis

Subsurface scattering

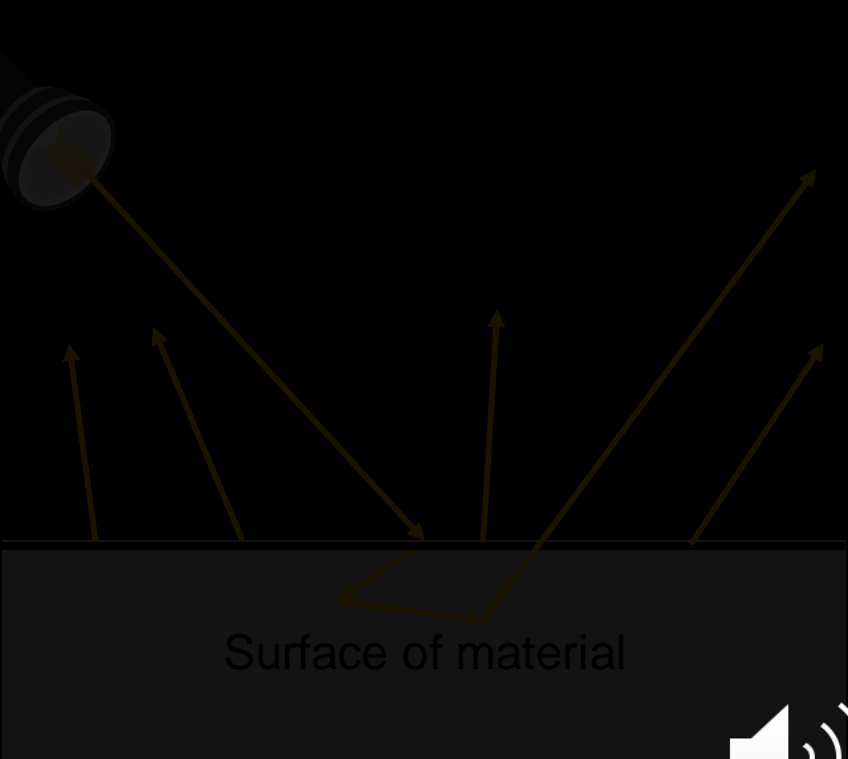
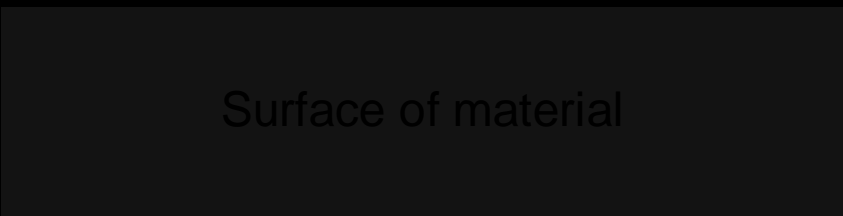

Motivation

Motivation Imaging Experiment

Spectral analysis

Spectral reflectance

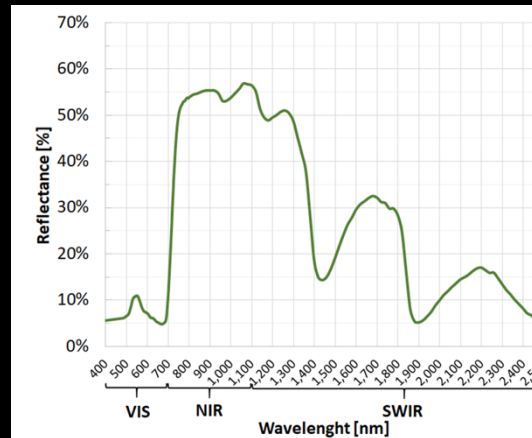

Subsurface scattering

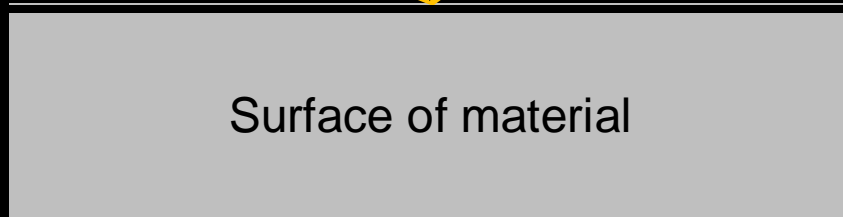

Surface of material

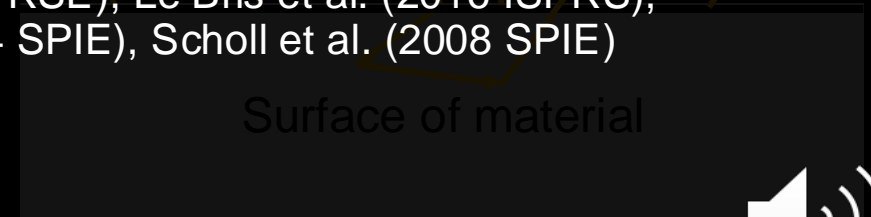

Surface of material

Liang et al. (2022, CVPR), Salamati et al. (2009 CIC),
Zhi et al. (2019 CVPR), Deshpande et al. (2019 JISRS),
Heiden et al. (2007 RSE), Le Bris et al. (2016 ISPRS),
Hege et al. (2004 SPIE), Scholl et al. (2008 SPIE)



Motivation

Motivation Imaging Experiment

Spectral analysis

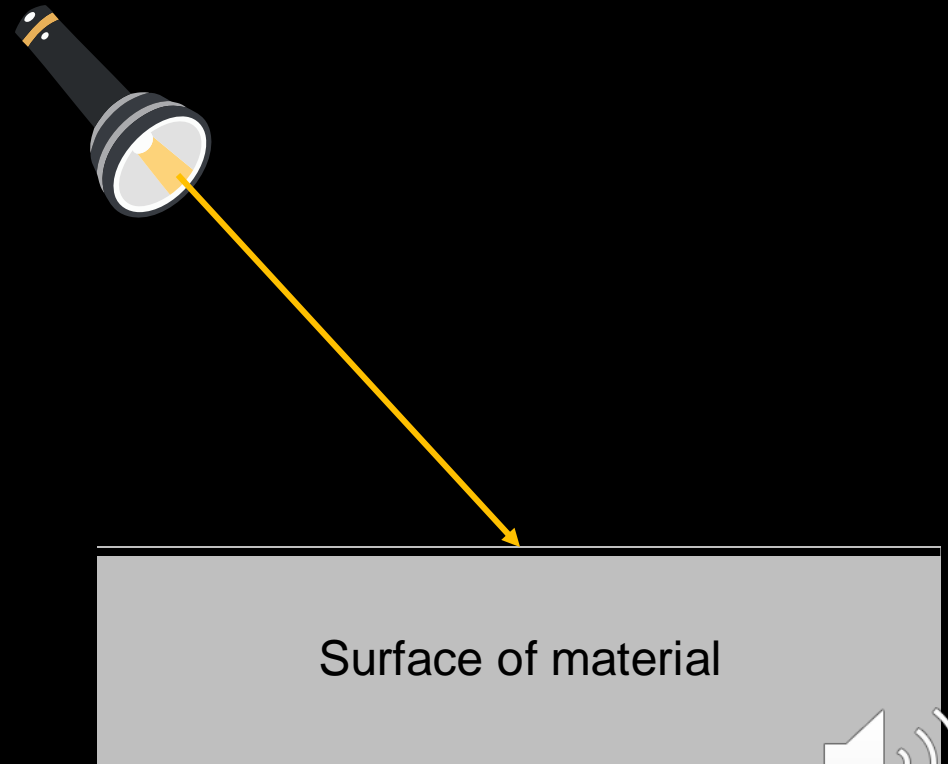
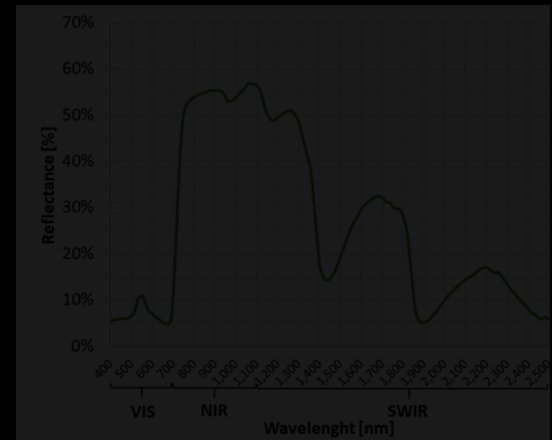
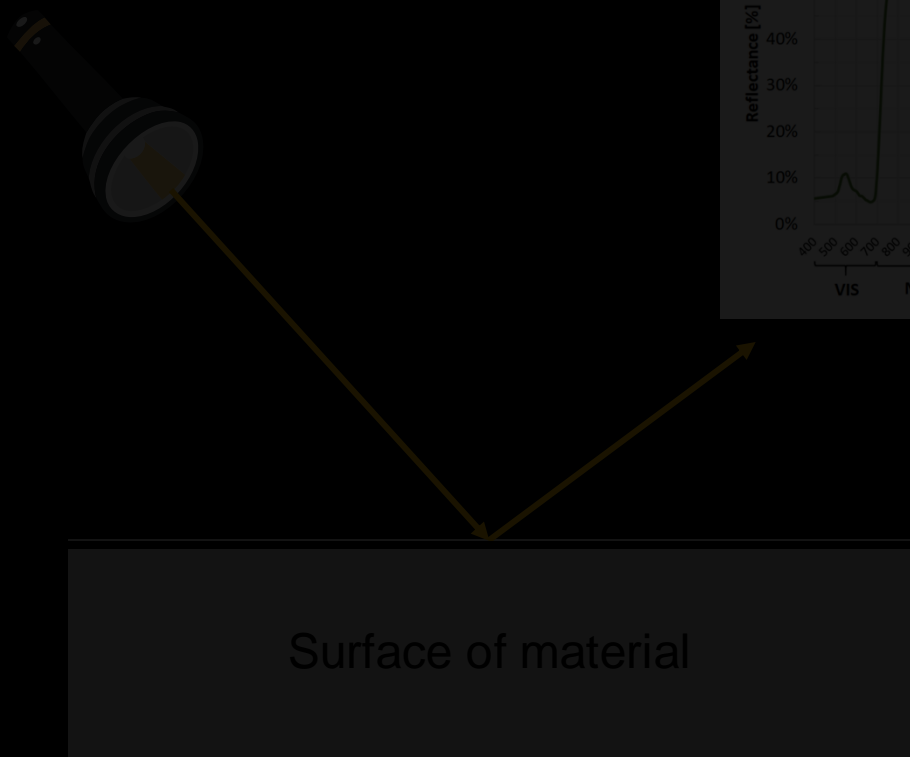

Liang et al., Salamati et al., Zhi et al., Deshpande et al., Heiden et al., Le Bris et al., Hege et al., Scholl et al.



Motivation

Spectral analysis

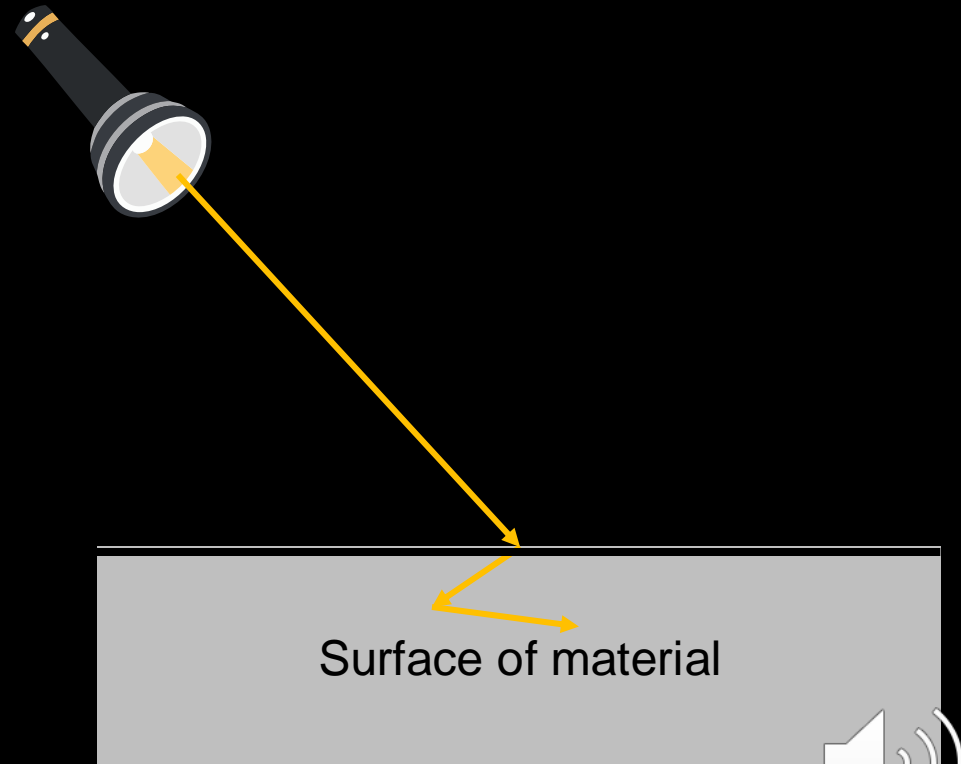
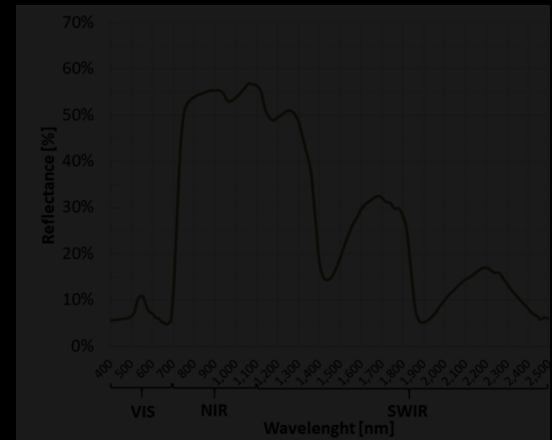
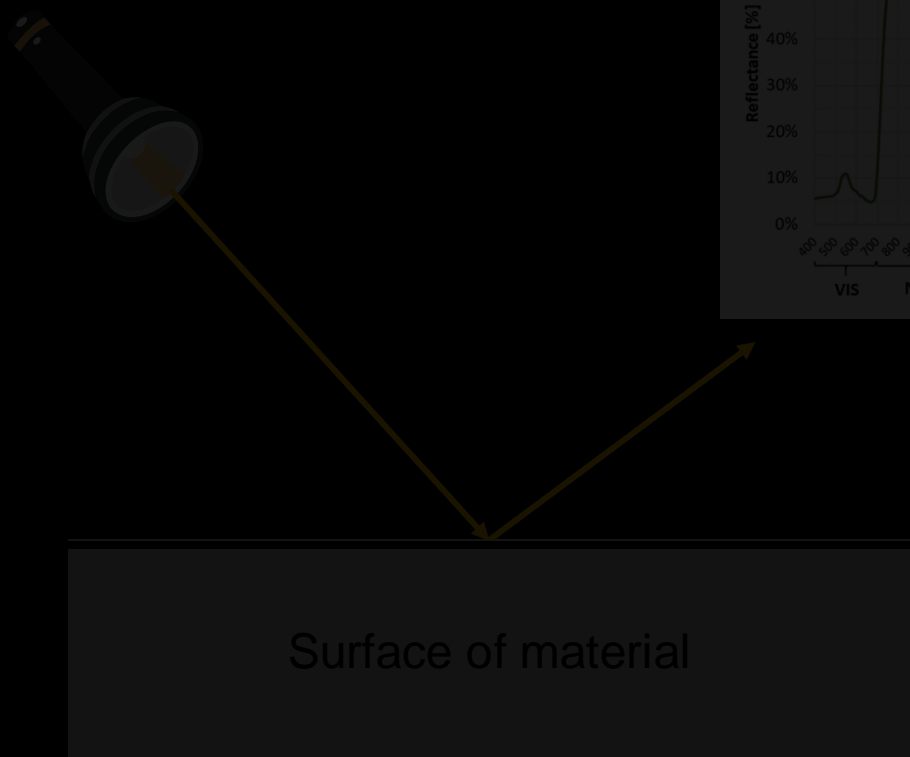

Motivation

Motivation Imaging Experiment

Spectral analysis

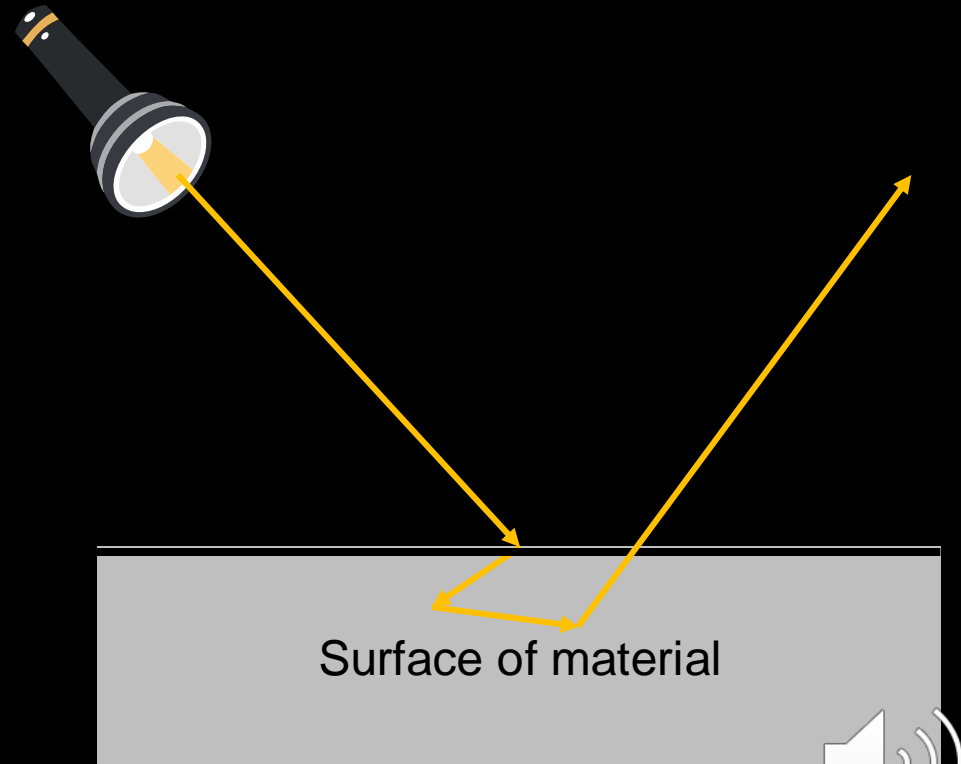
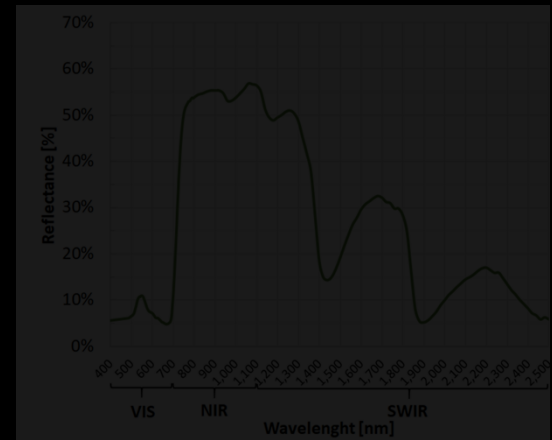
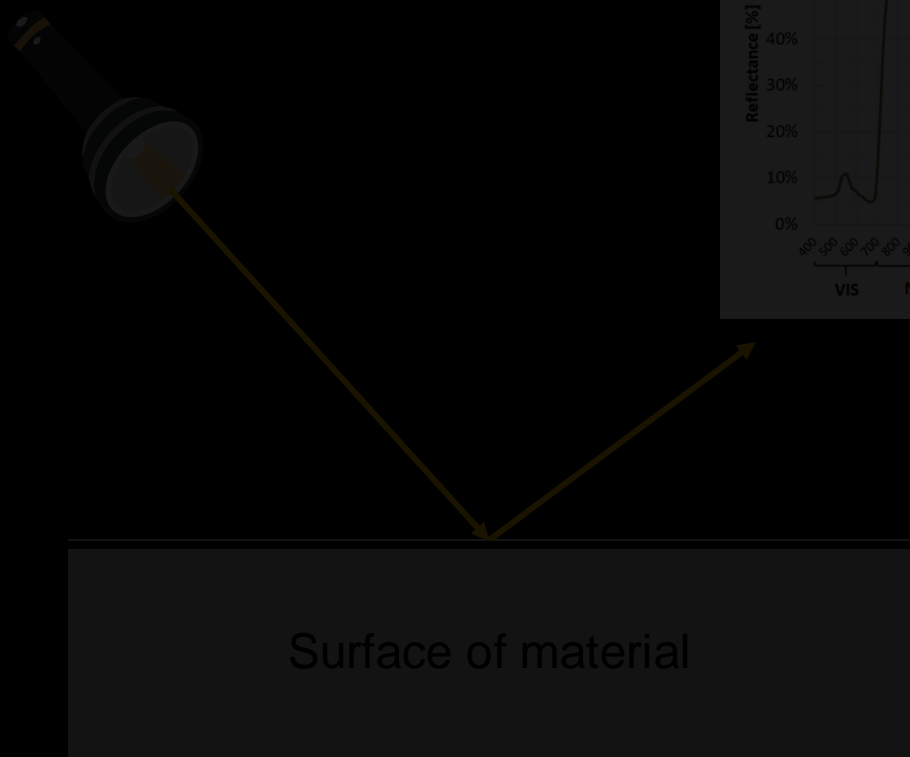

Motivation

Motivation Imaging Experiment

Spectral analysis

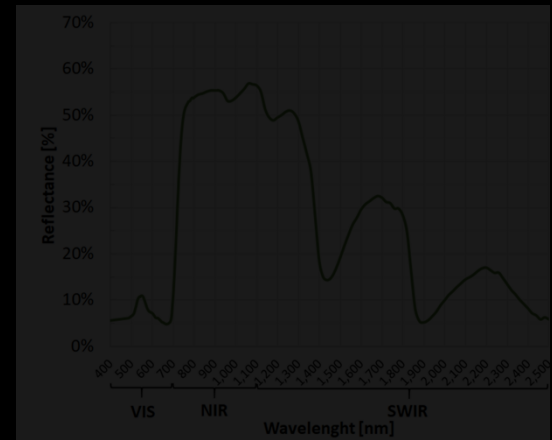
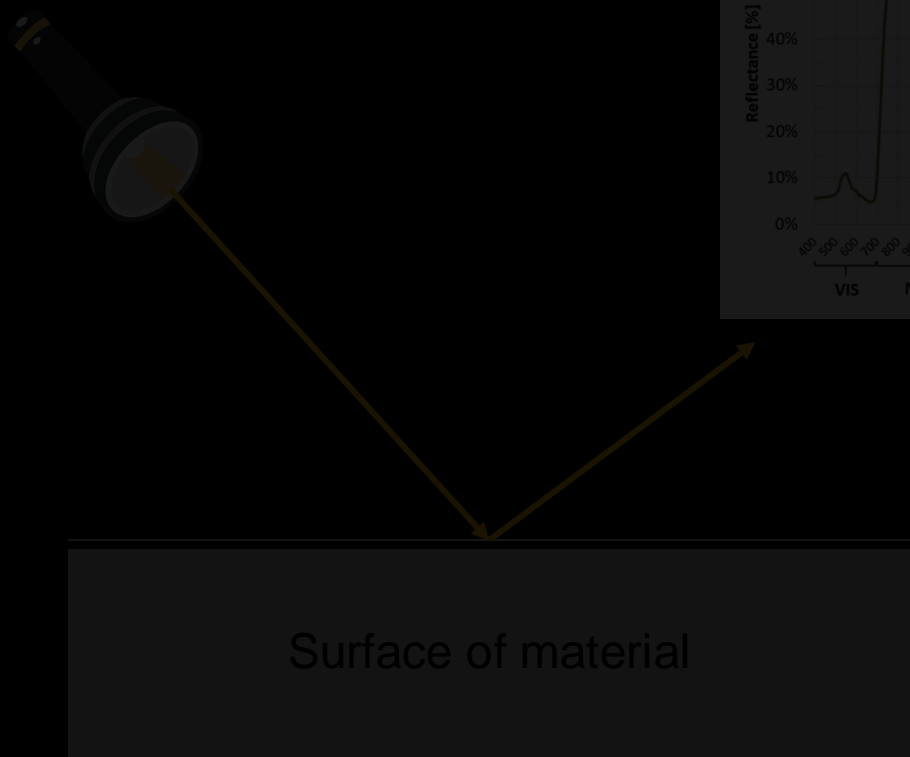

Subsurface scattering

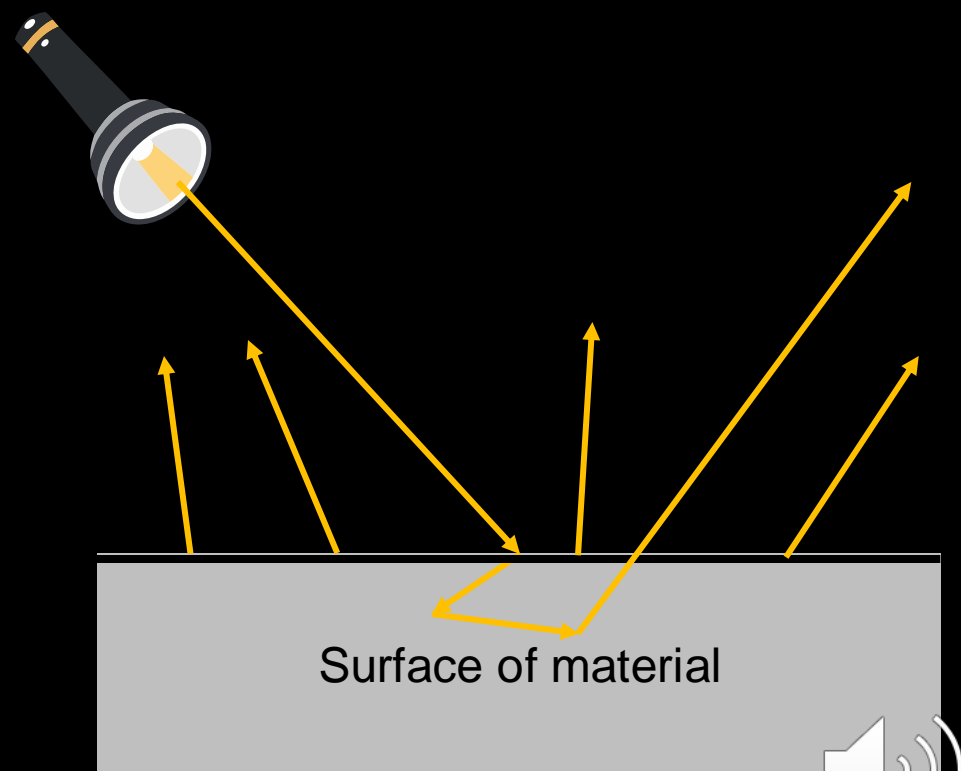

Motivation

Motivation Imaging Experiment

Spectral analysis

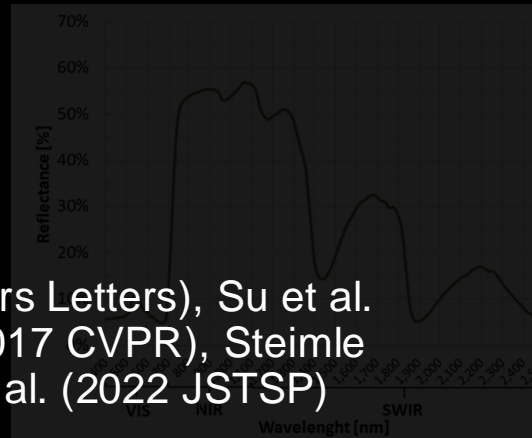

Conde et al. (2020 IEEE Sensors Letters), Su et al. (2016 CVPR), Tanaka et al. (2017 CVPR), Steimle et al. (2013 SIGCHI), Mao et al. (2022 JSTSP)

Surface of material

Liang et al., Salamati et al., Zhi et al., Deshpande et al., Heiden et al., Le Bris et al., Hege et al., Scholl et al.

(Broadband)
Subsurface scattering

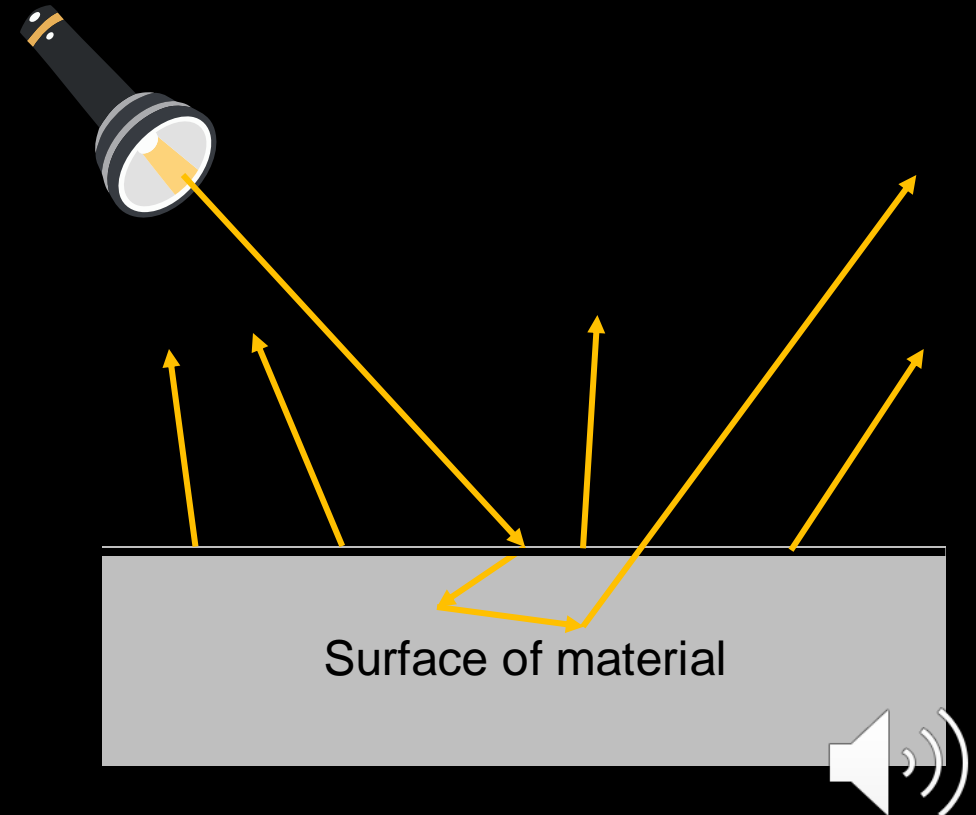

Motivation

Subsurface scattering

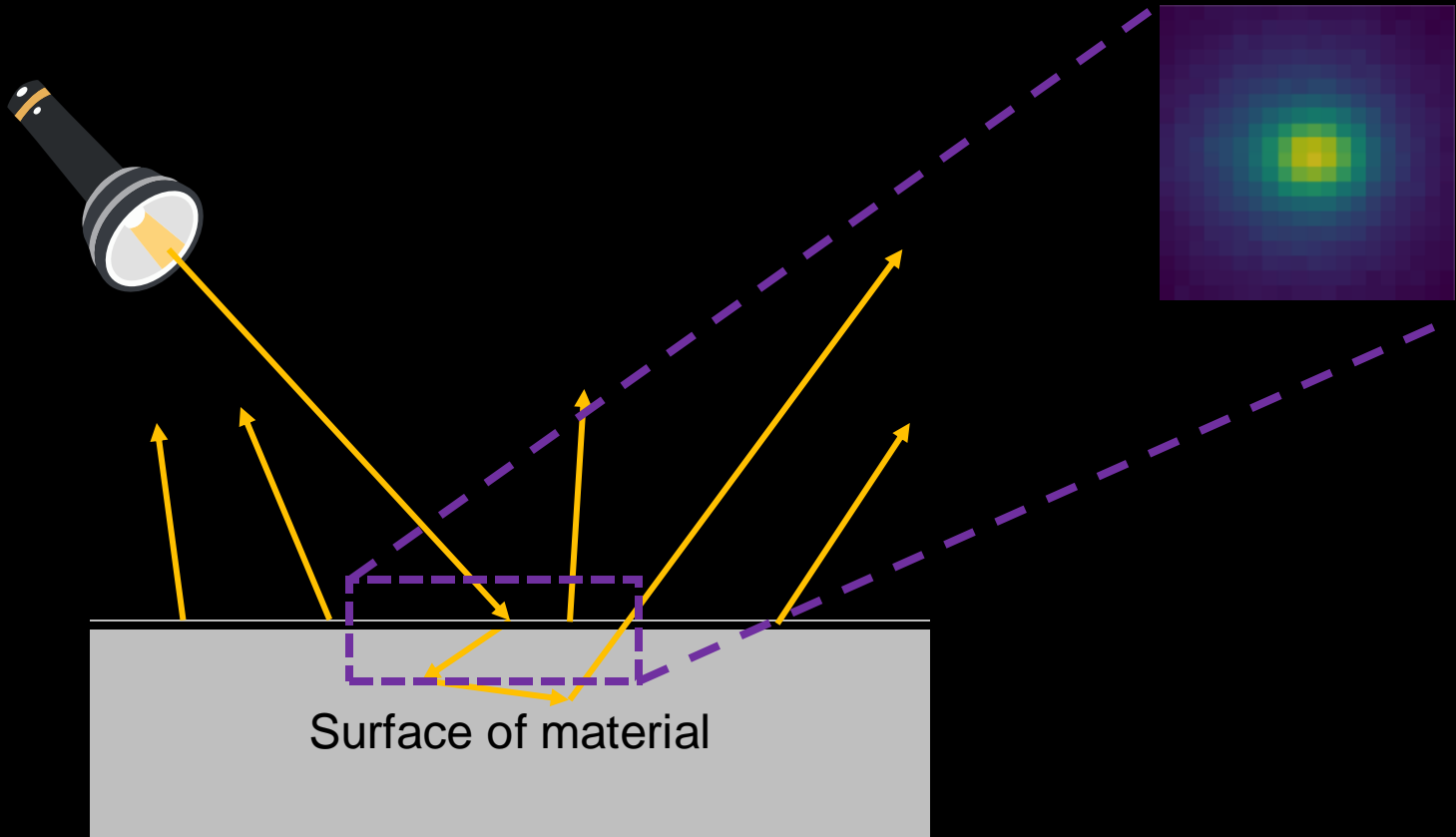

Motivation

Subsurface scattering

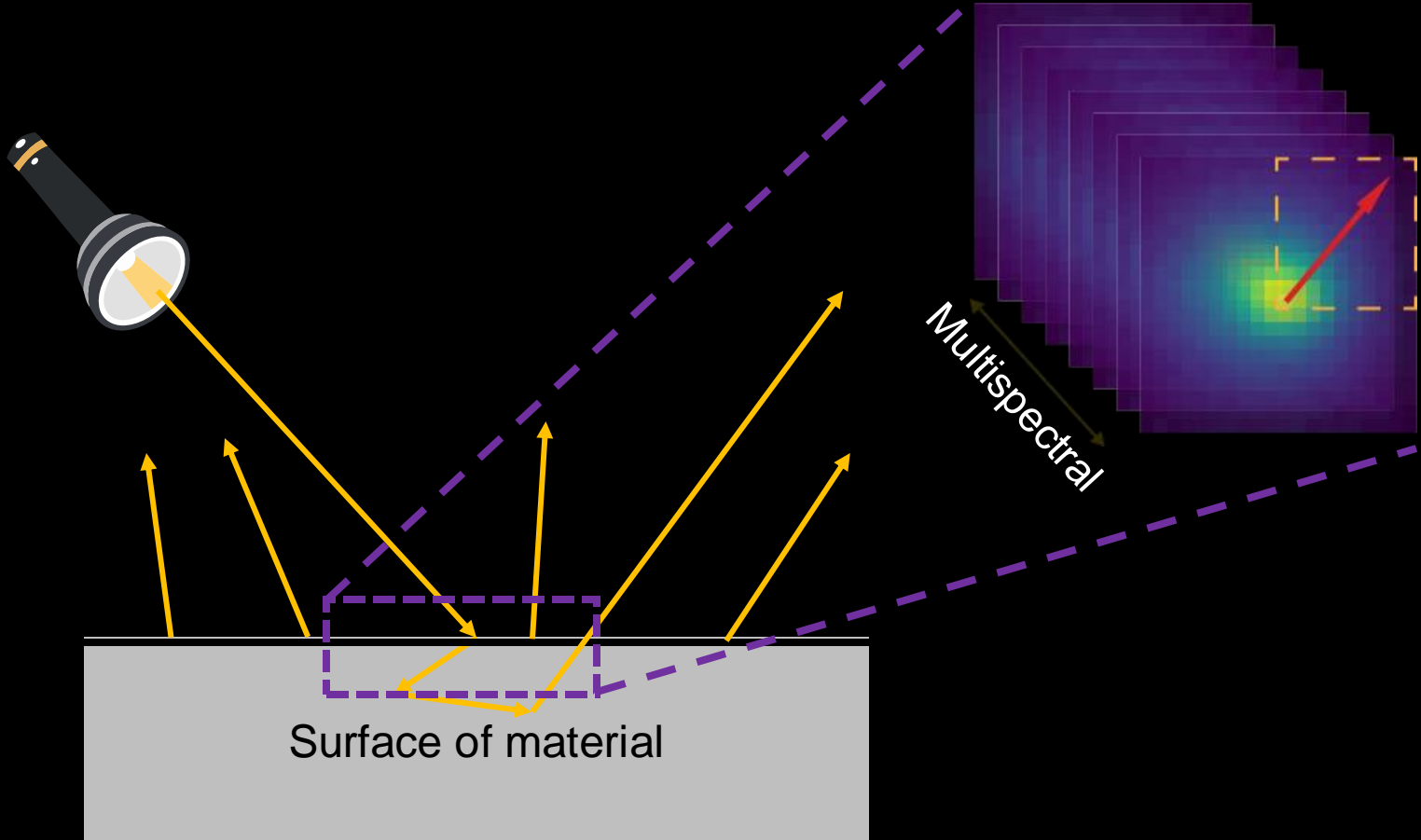

Motivation

Subsurface scattering

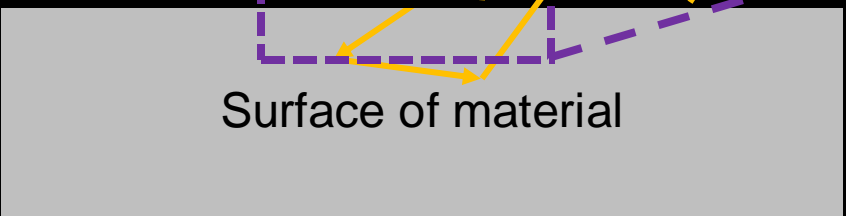

Surface of material

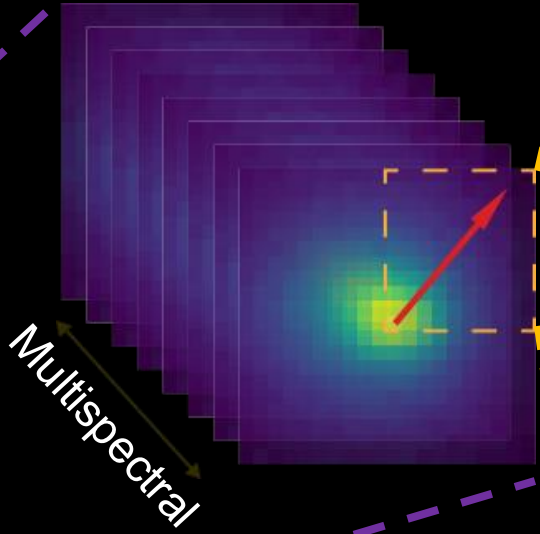

Multispectral

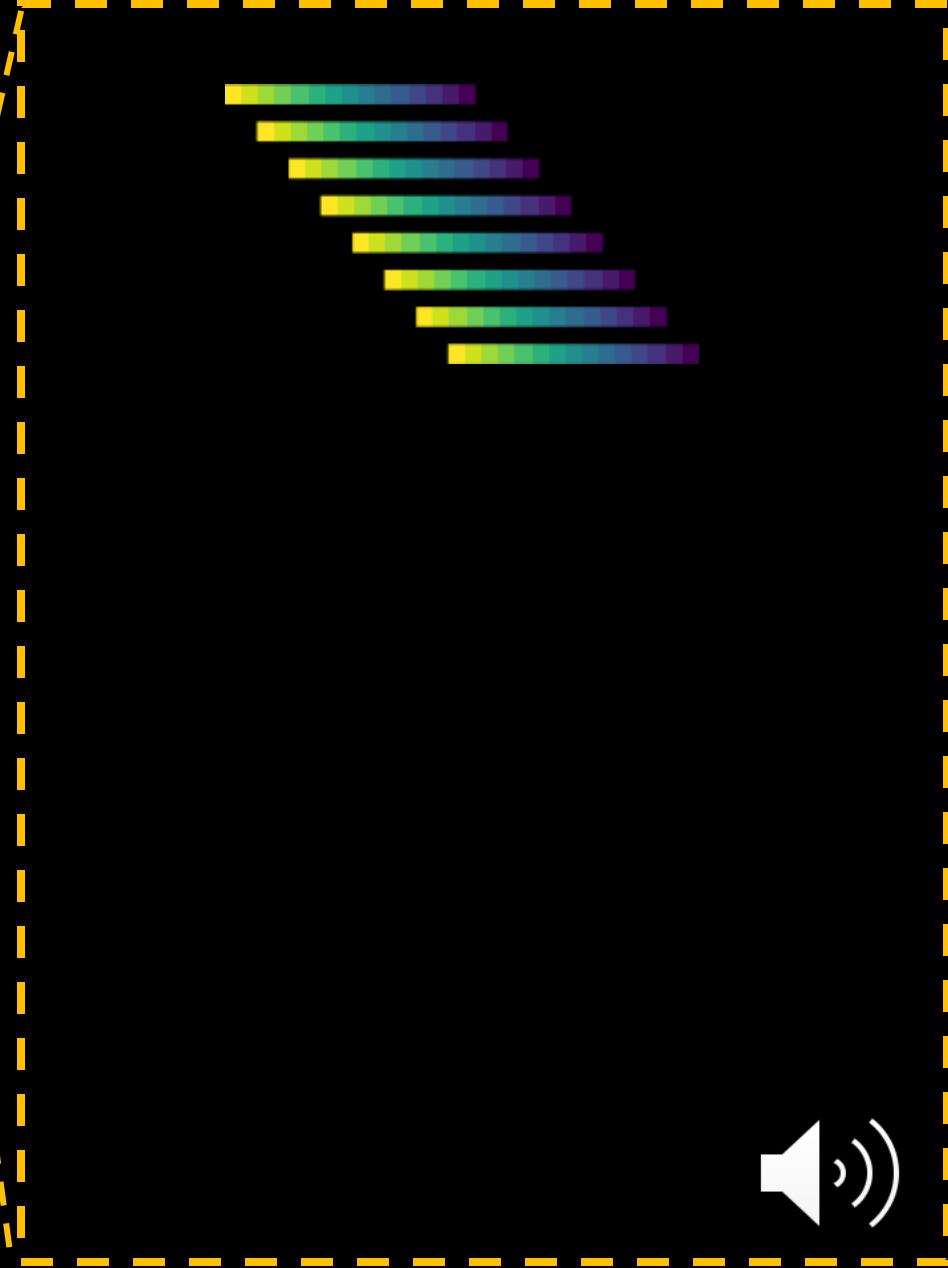

Motivation

Subsurface scattering

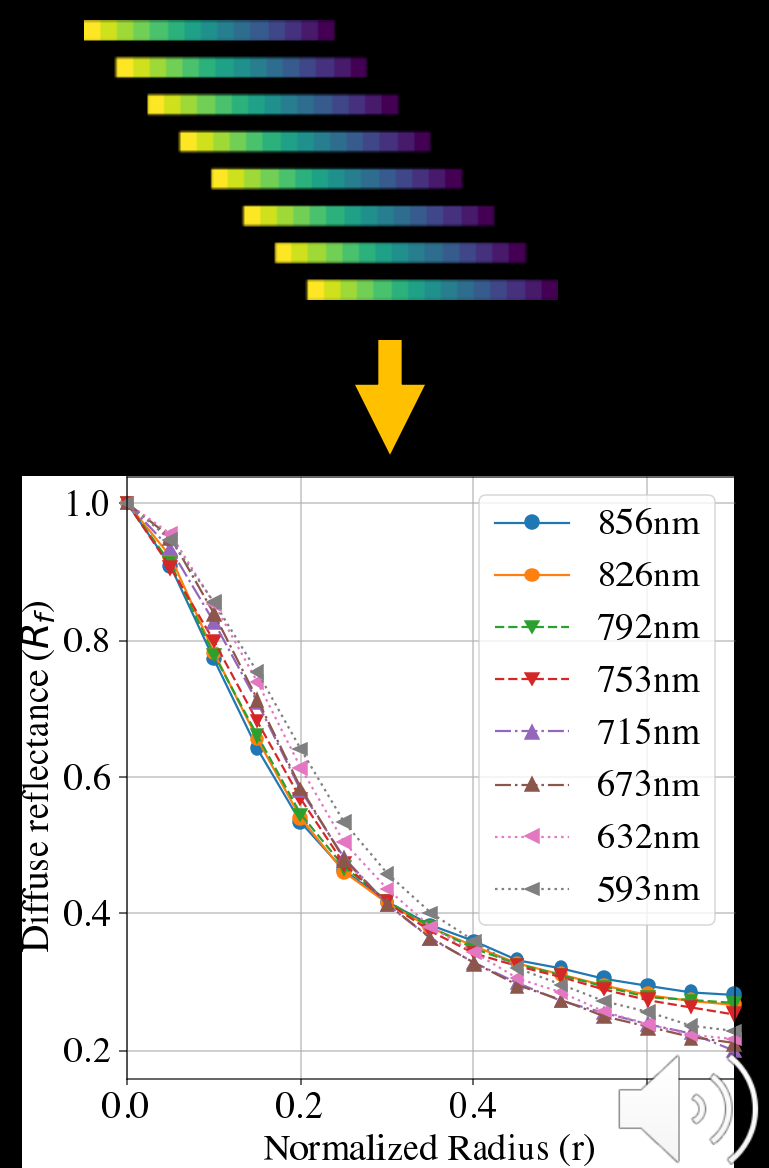
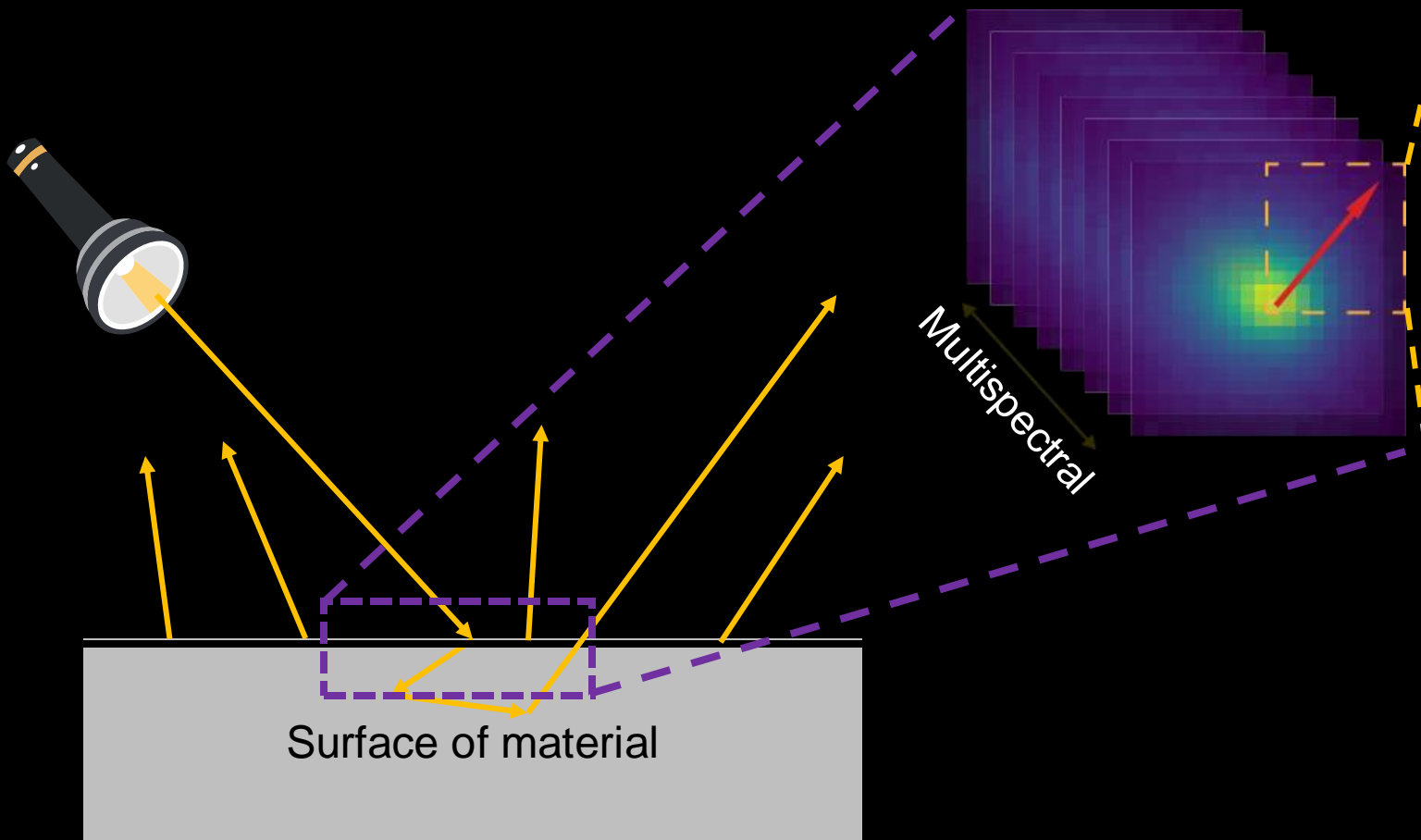

Motivation

Motivation Imaging Experiment

Subsurface scattering

Scattering is function of wavelength

Multispectral

Surface of material

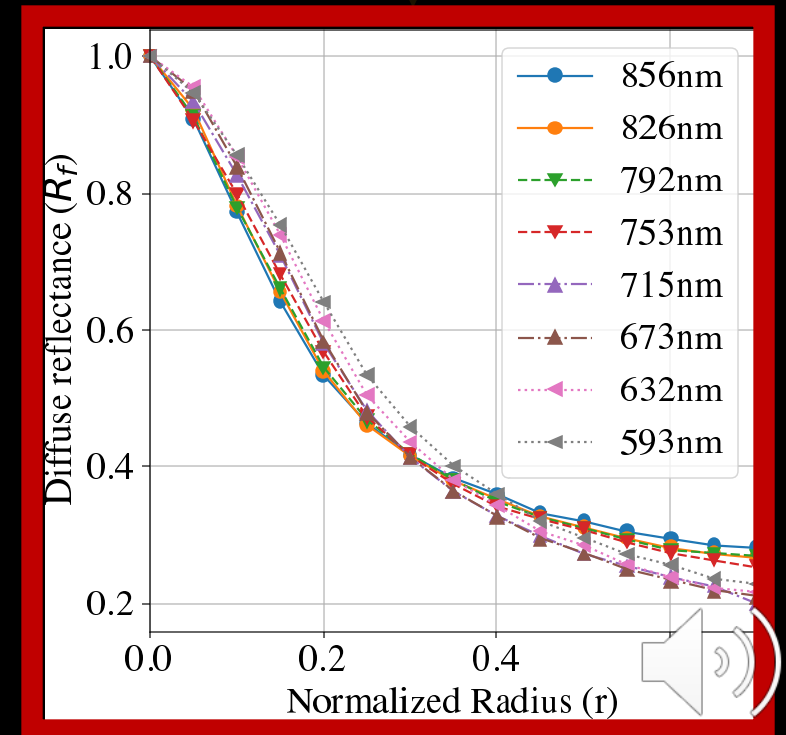

Motivation

Motivation Imaging Experiment

Subsurface scattering

Scattering is function of wavelength



Surface of material

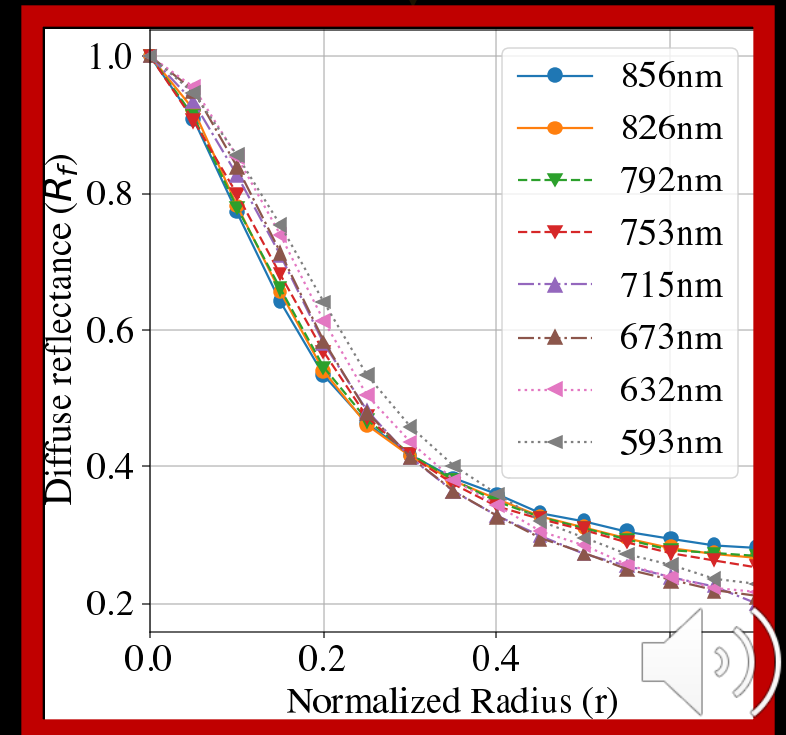

Motivation

Motivation Imaging Experiment

Spectral analysis

Subsurface scattering



Surface of material

Surface of material

Liang et al., Salamati et al., Zhi et al., Deshpande et al.,
Heiden et al., Le Bris et al., Hege et al., Scholl et al.

Conde et al., Su et al., Tanaka et al.,
Steimle et al., Mao et al.



Motivation

Motivation Imaging Experiment

Spectral analysis

Subsurface scattering

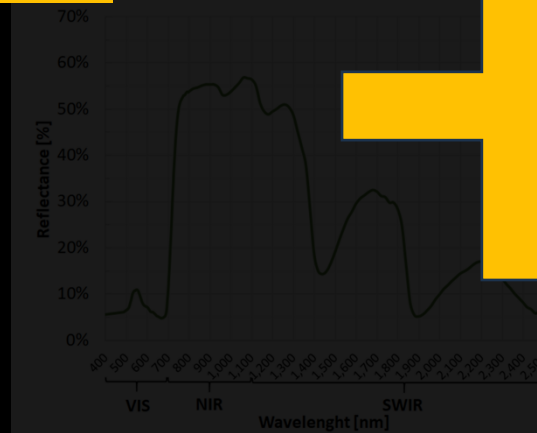

Spectral Sub-Surface Scattering (S^4) imaging

Liang et al., Salamati et al., Zhi et al., Deshpande et al.,
Heiden et al., Le Bris et al., Hege et al., Scholl et al.

Conde et al., Su et al., Tanaka et al.,
Steimle et al., Mao et al.



S^4 Imaging

Motivation Imaging Experiment

Multi-shot



Single-shot

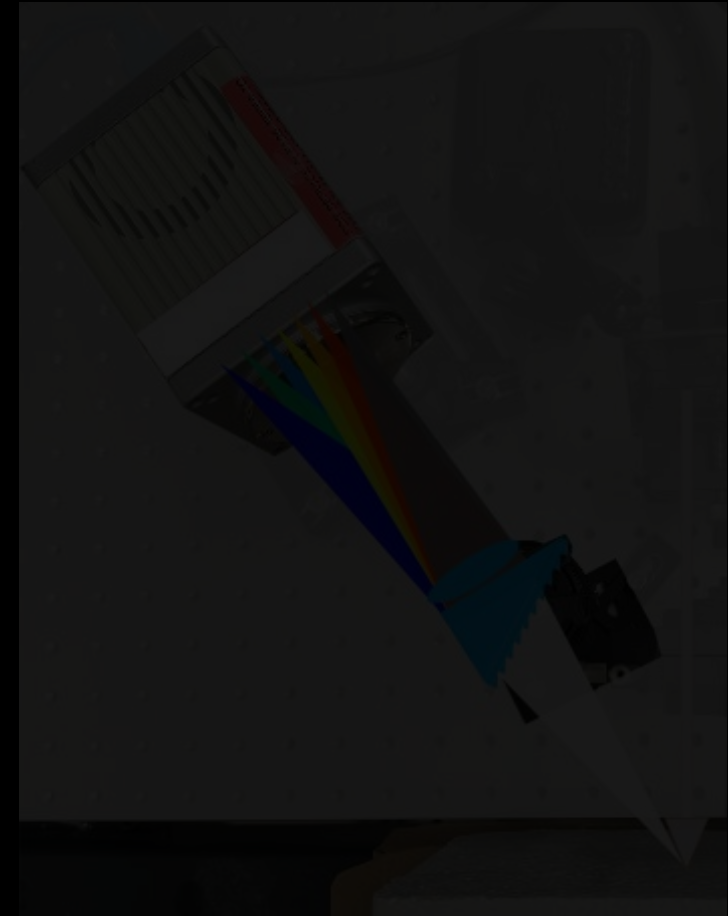

S⁴ Imaging

Motivation Imaging Experiment

Multi-shot

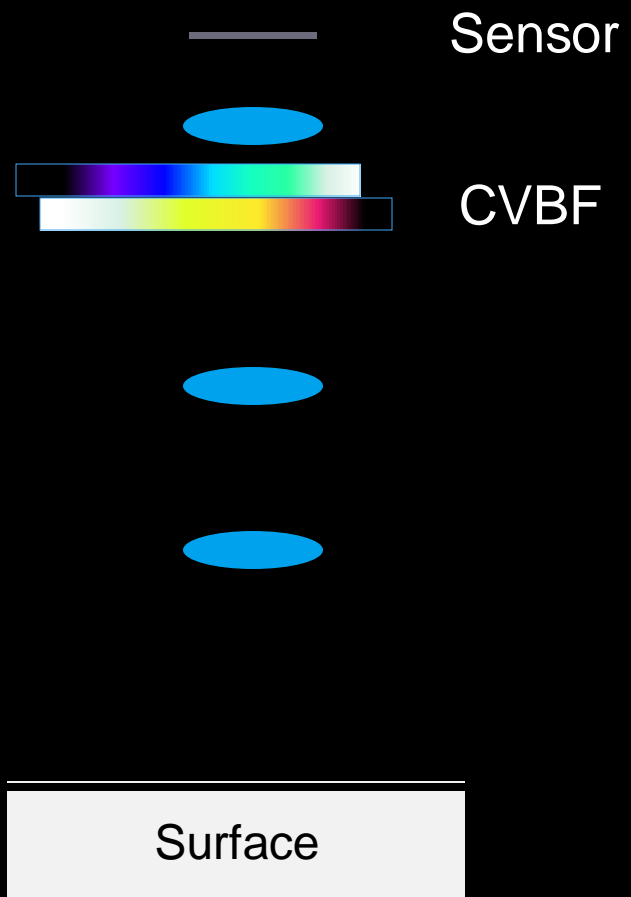

S⁴ Imaging

Motivation Imaging Experiment

Multi-shot

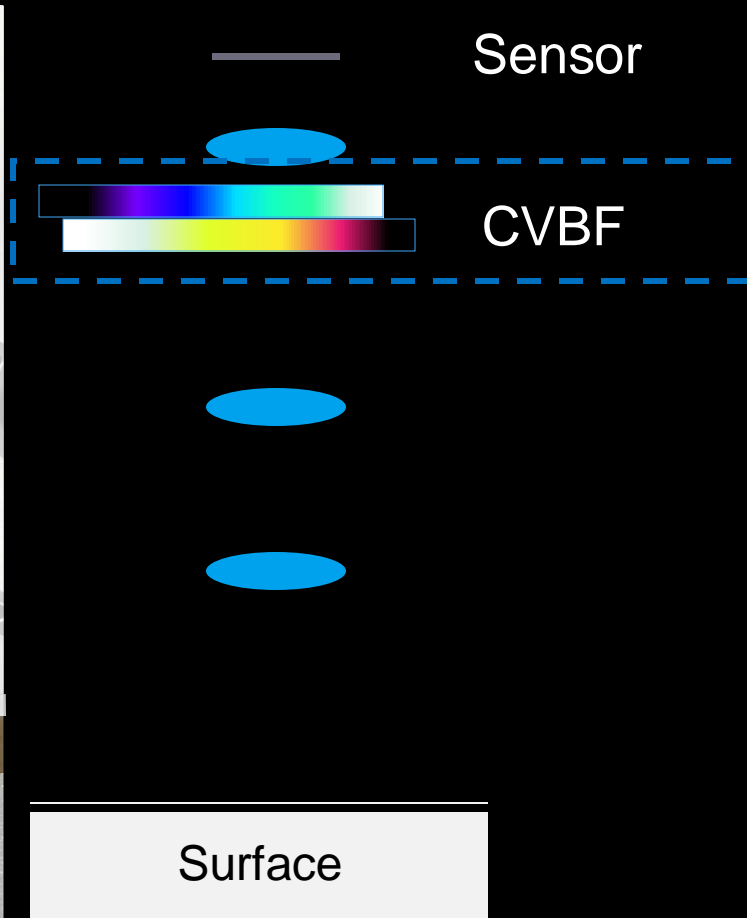

S⁴ Imaging

Motivation Imaging Experiment

Multi-shot

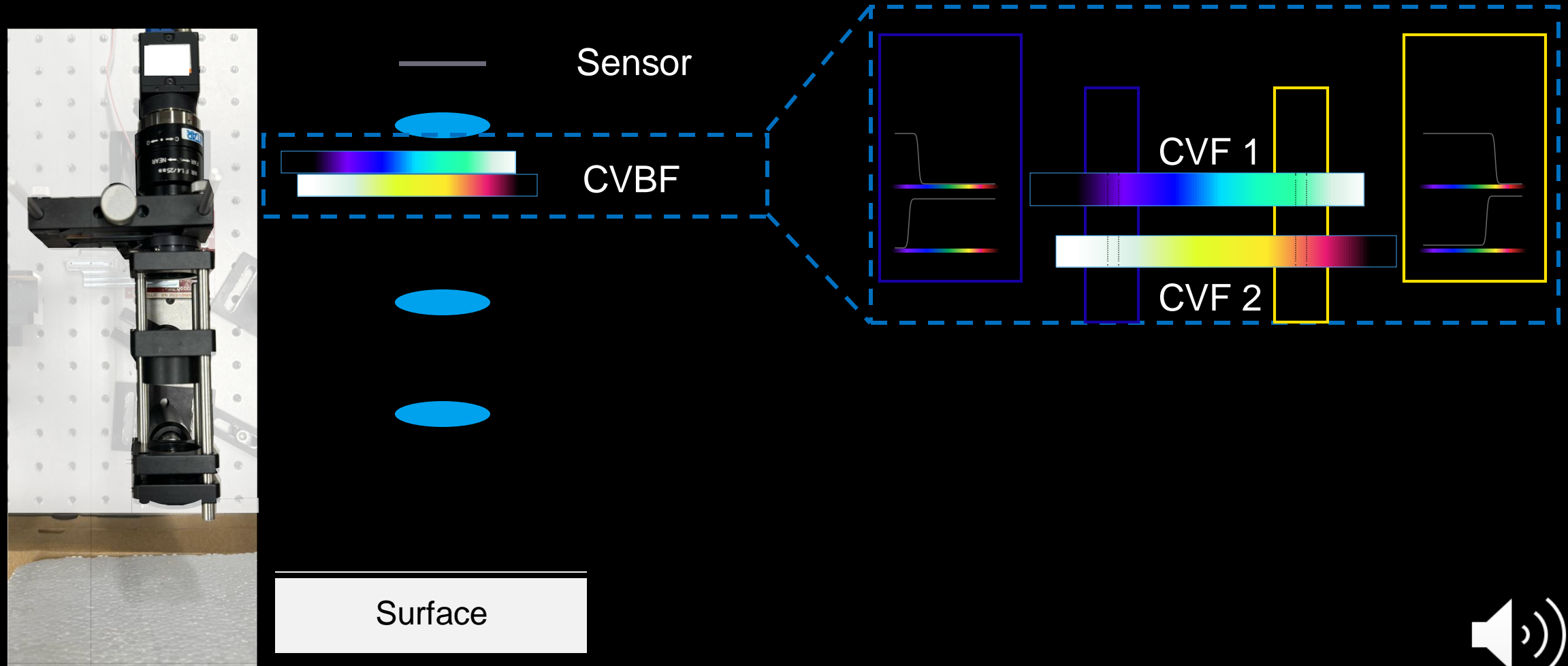

S⁴ Imaging

Motivation Imaging Experiment

Multi-shot

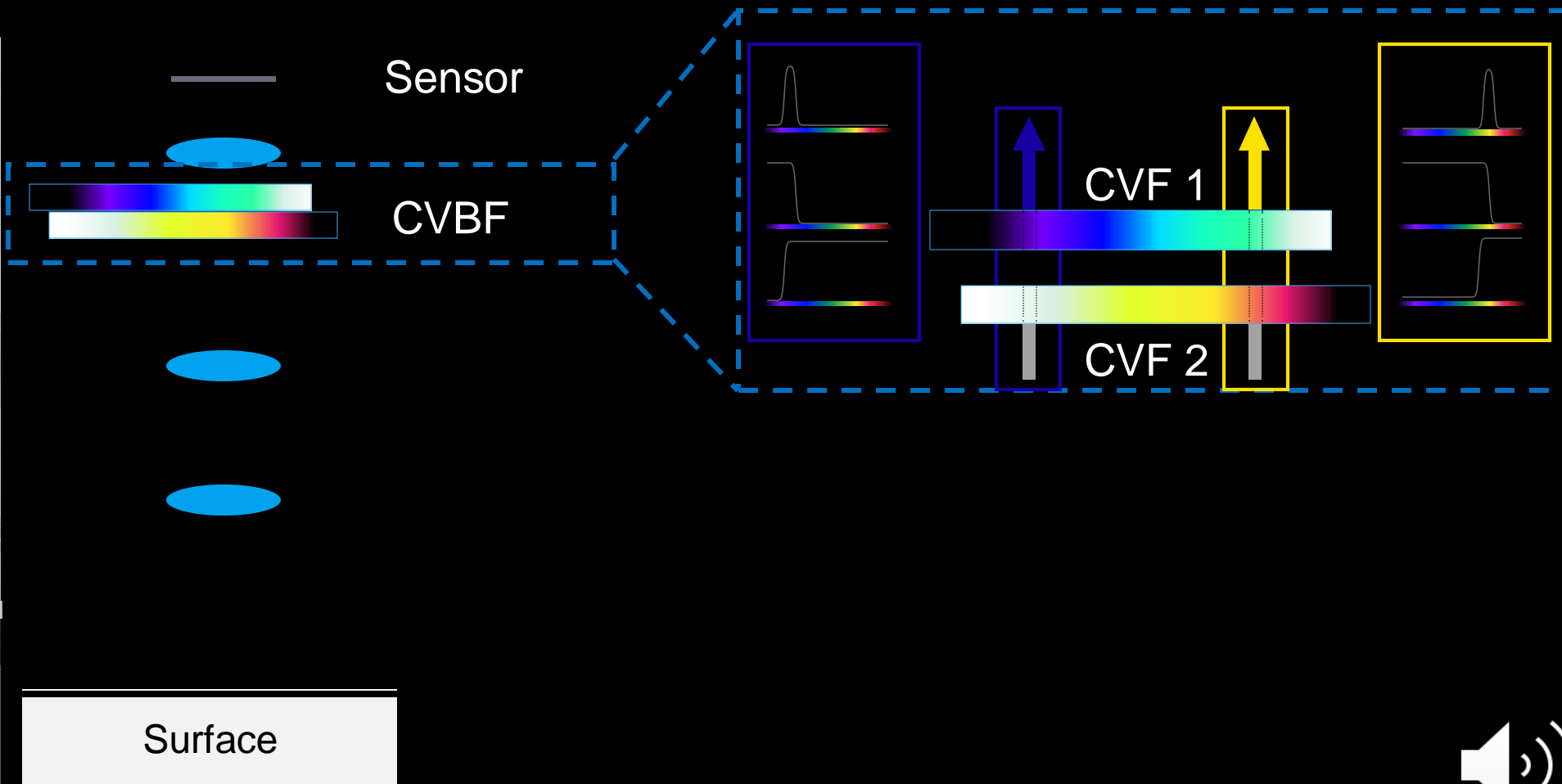

S⁴ Imaging

Motivation Imaging Experiment

Multi-shot

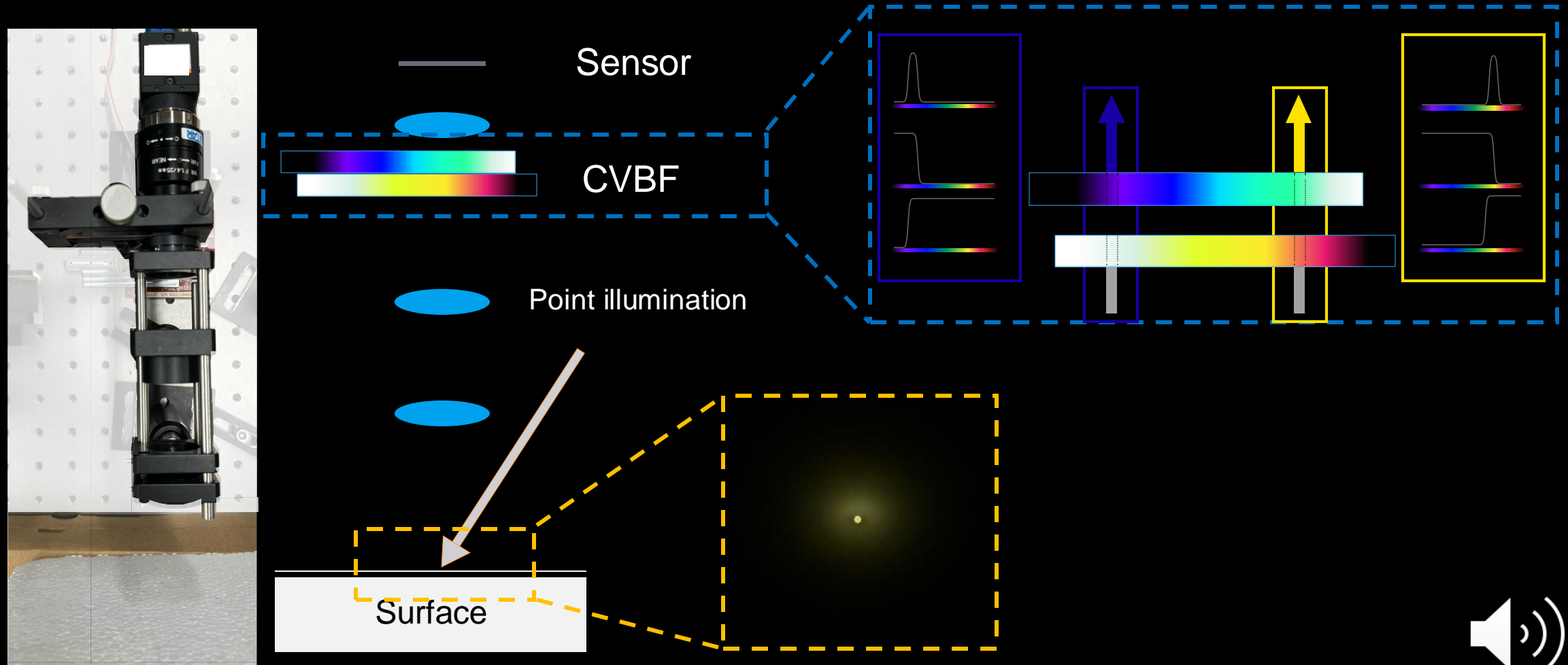

S⁴ Imaging

Motivation Imaging Experiment

Multi-shot

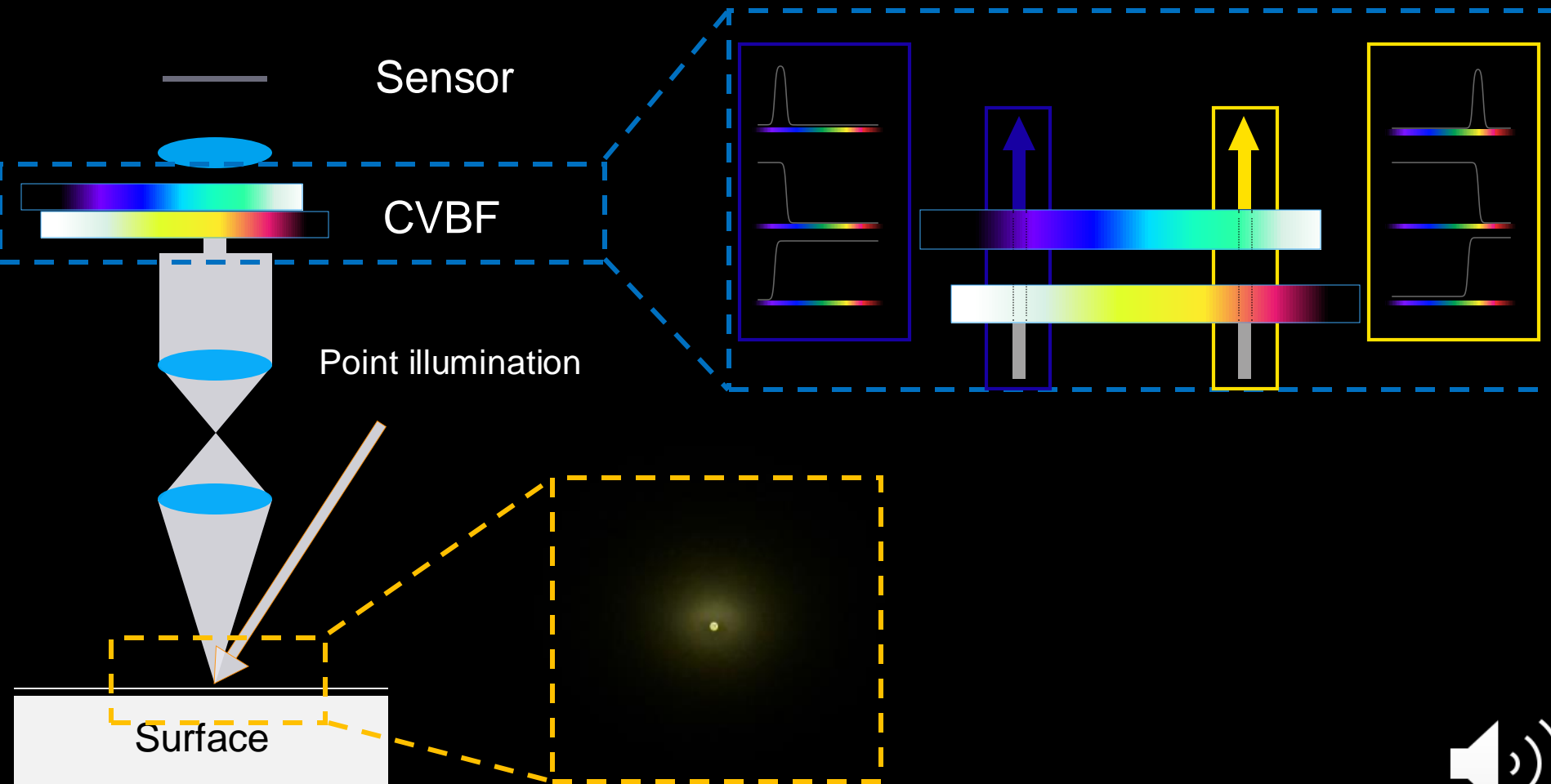

S^4 Imaging

Motivation Imaging Experiment

Multi-shot

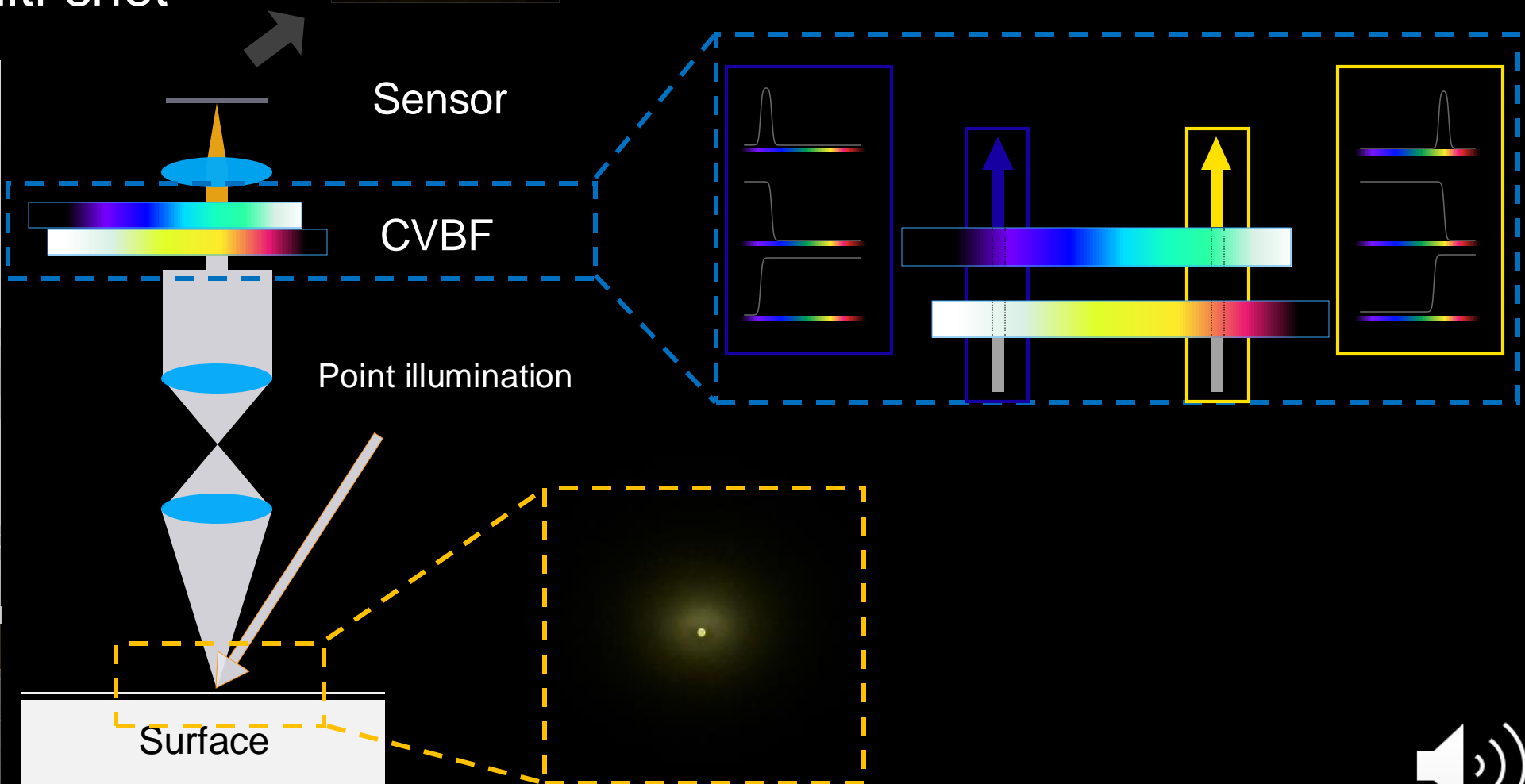
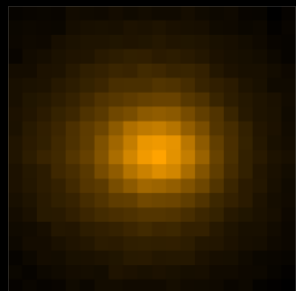

S^4 Imaging

Motivation Imaging Experiment

Multi-shot

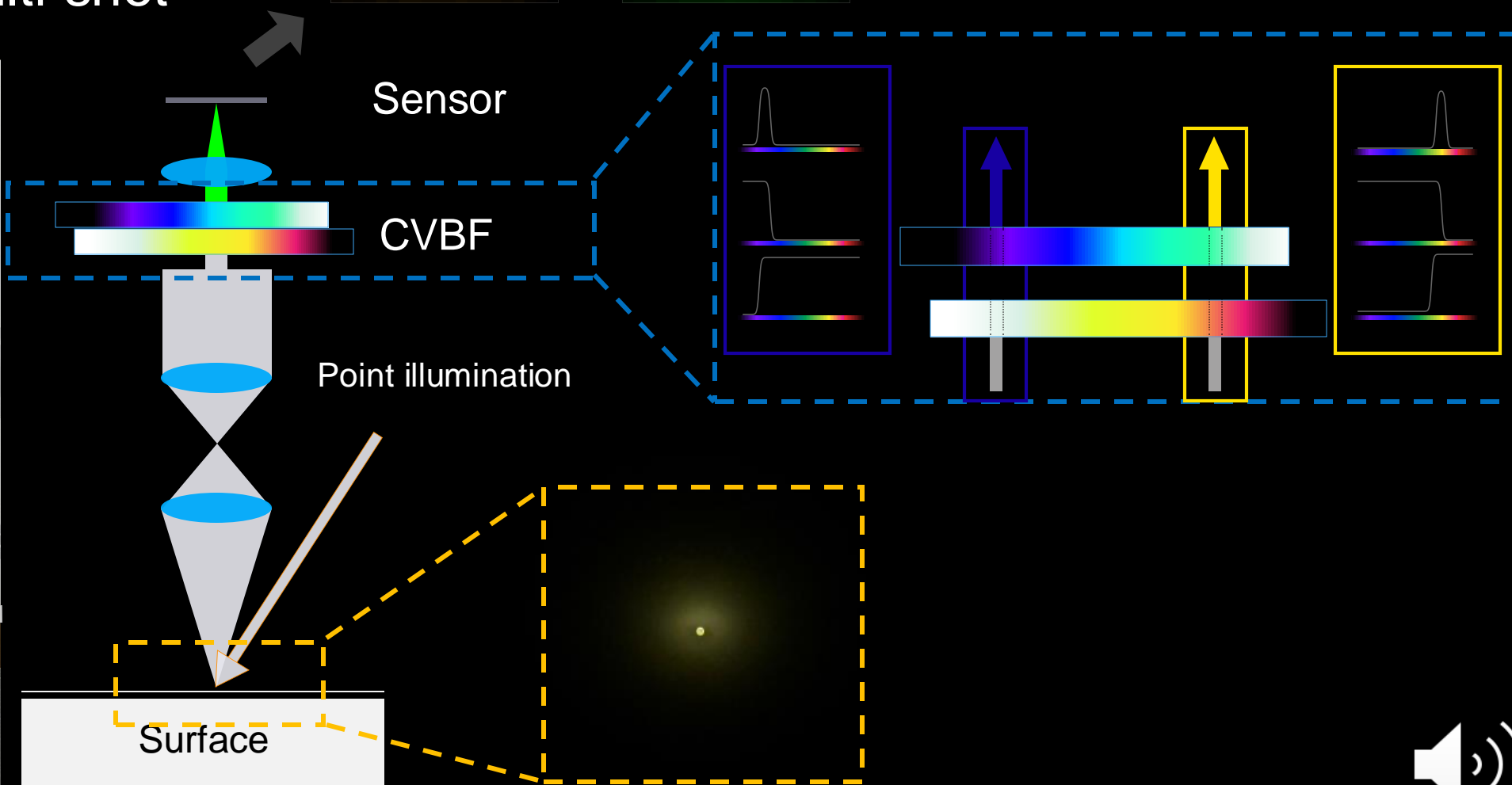
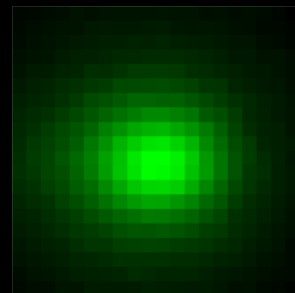
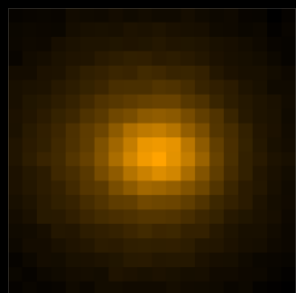

S^4 Imaging

Multi-shot

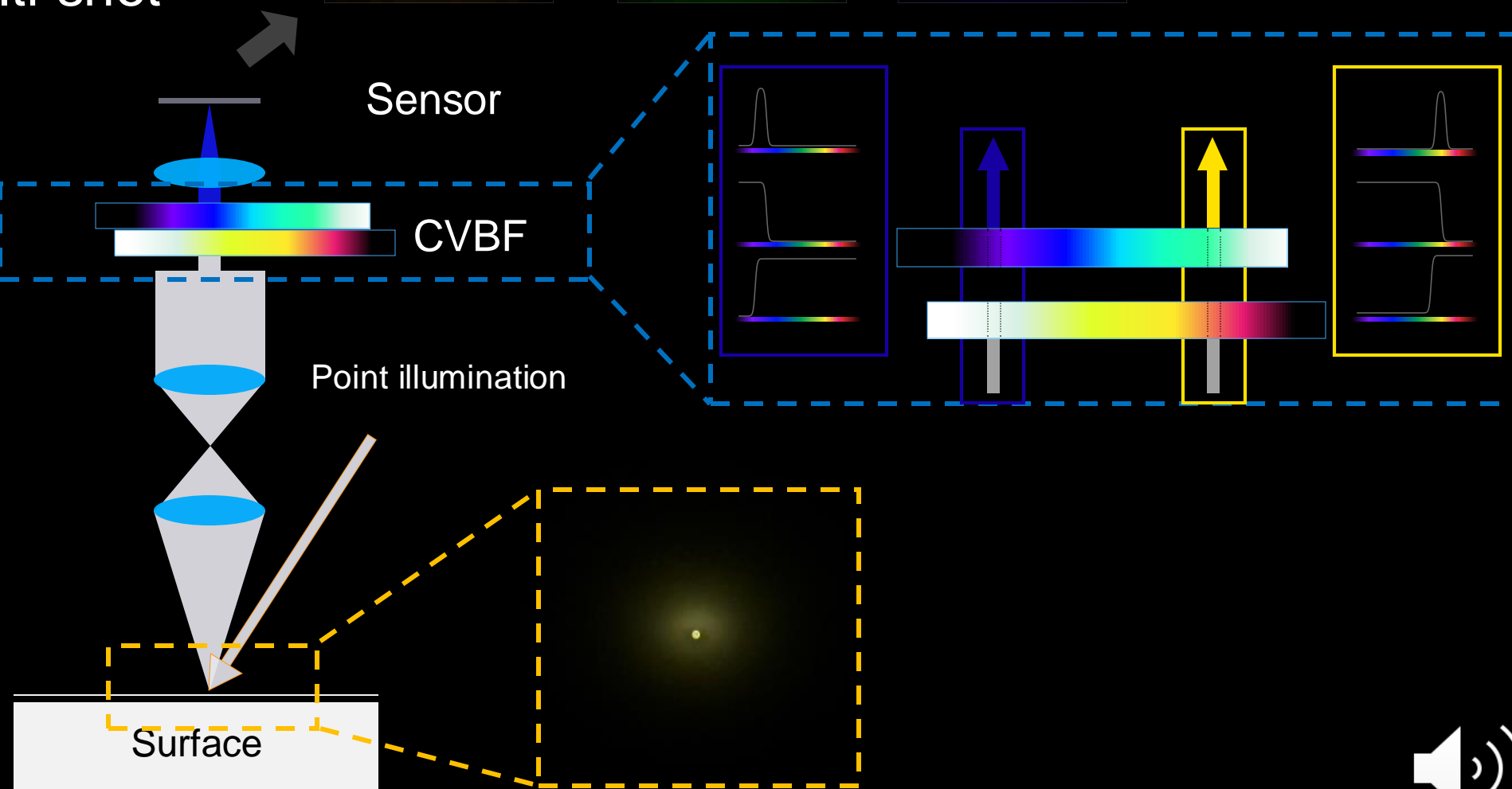
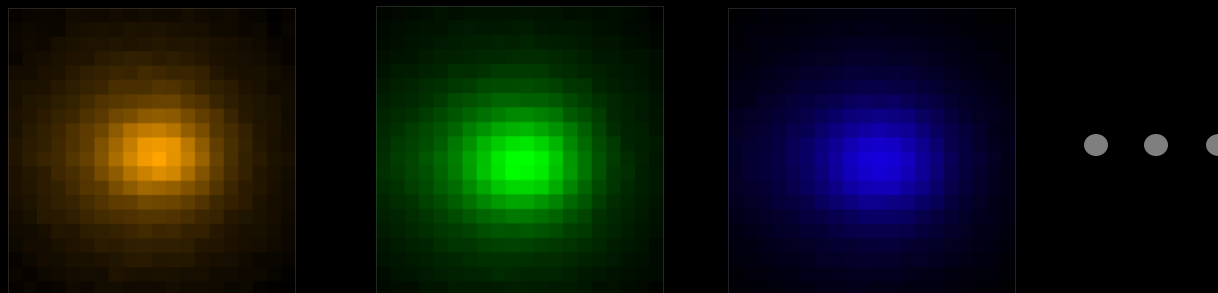

S⁴ Imaging

Motivation Imaging Experiment

Multi-shot

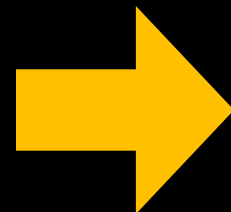
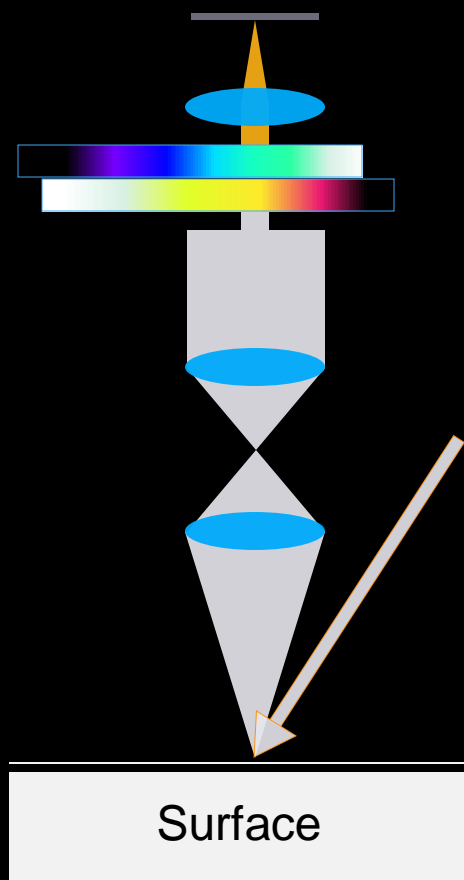

Time
consuming



S⁴ Imaging

Motivation Imaging Experiment

Multi-shot



Single-shot

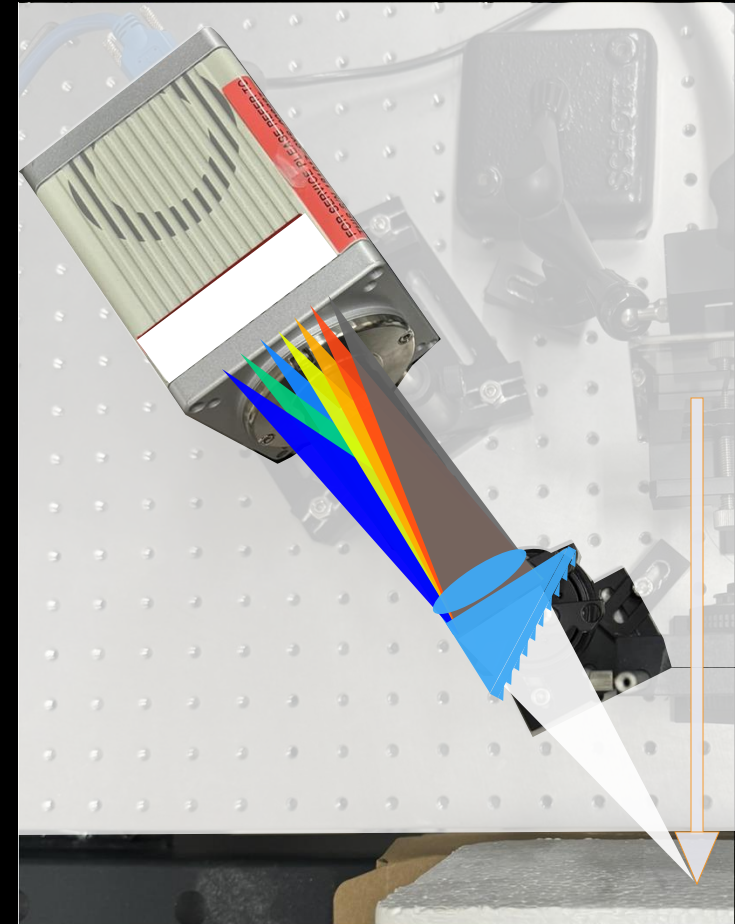

S⁴ Imaging

Motivation Imaging Experiment

Single-shot



S⁴ Imaging

Motivation Imaging Experiment

Single-shot

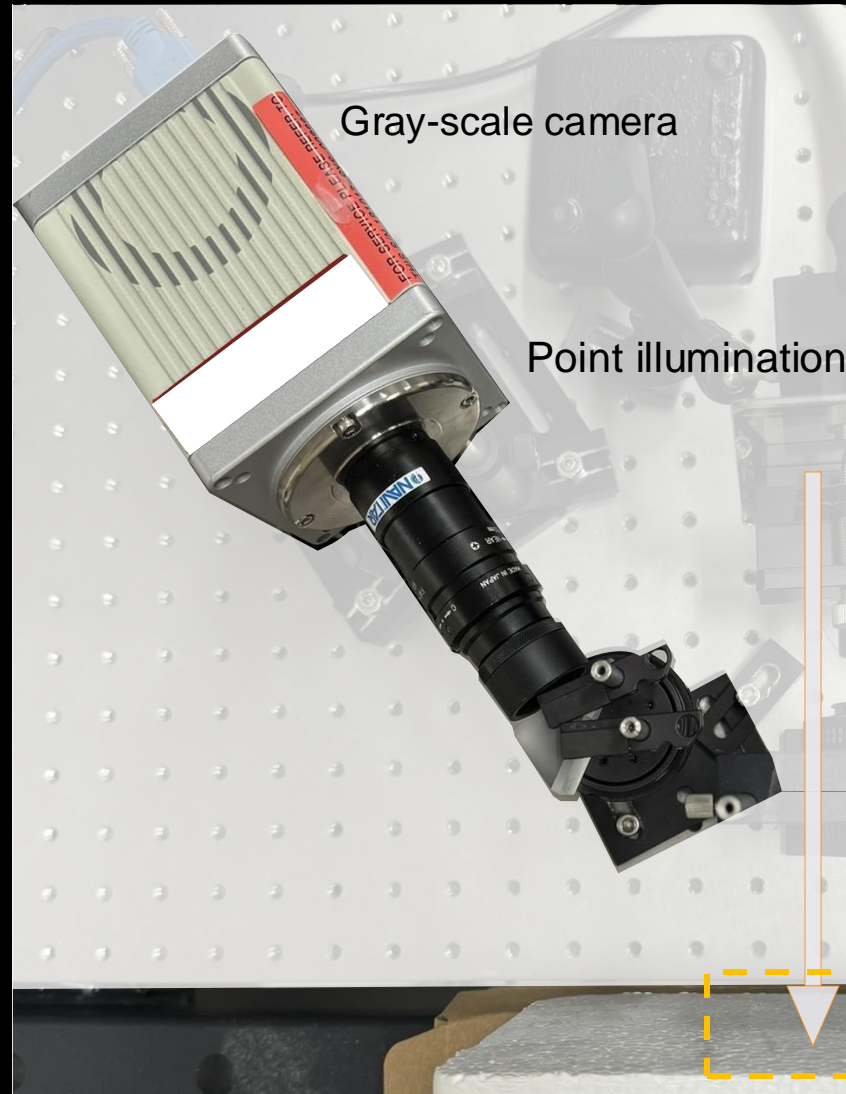

S⁴ Imaging

Motivation Imaging Experiment

Single-shot

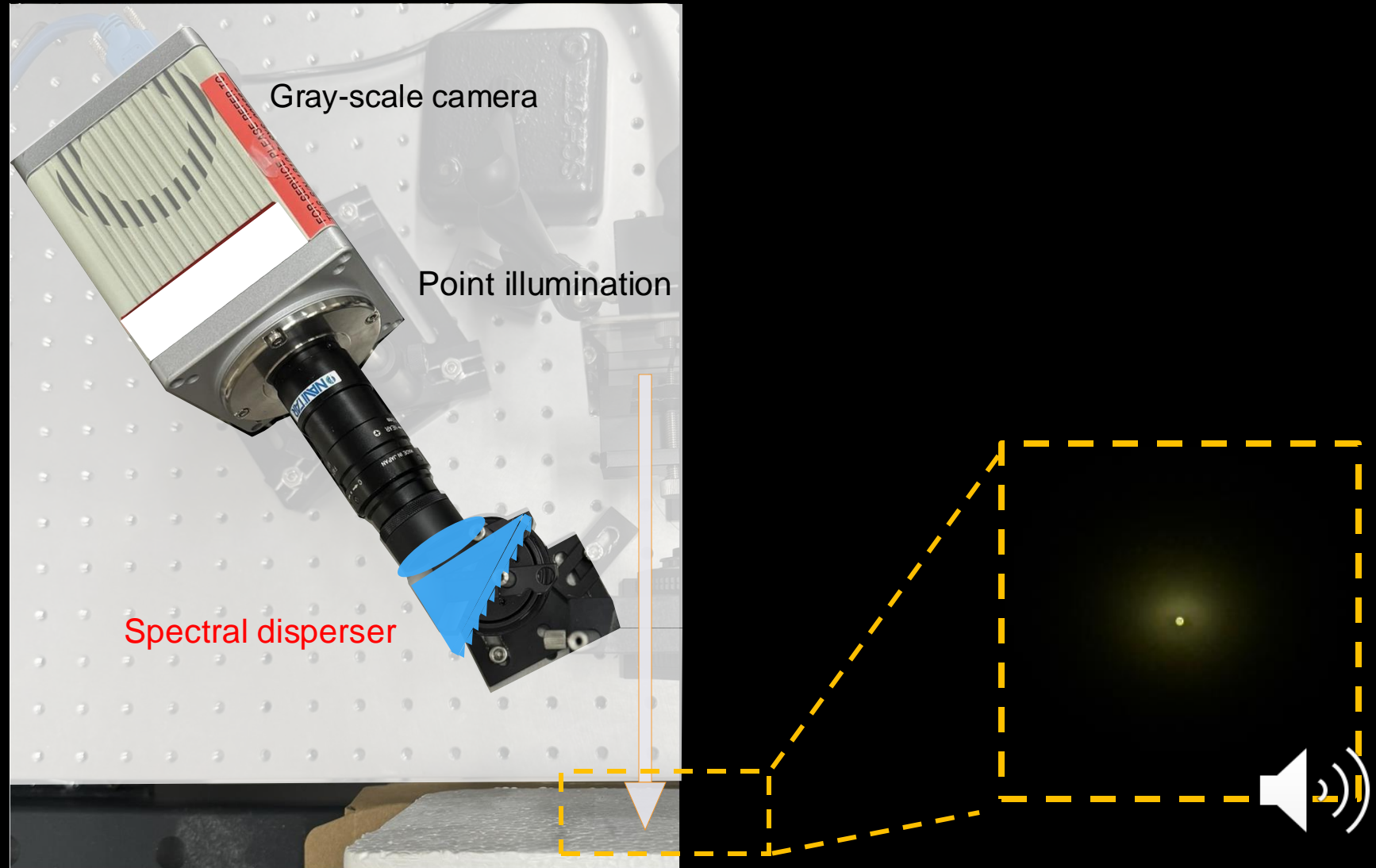

S⁴ Imaging

Single-shot

Motivation Imaging Experiment

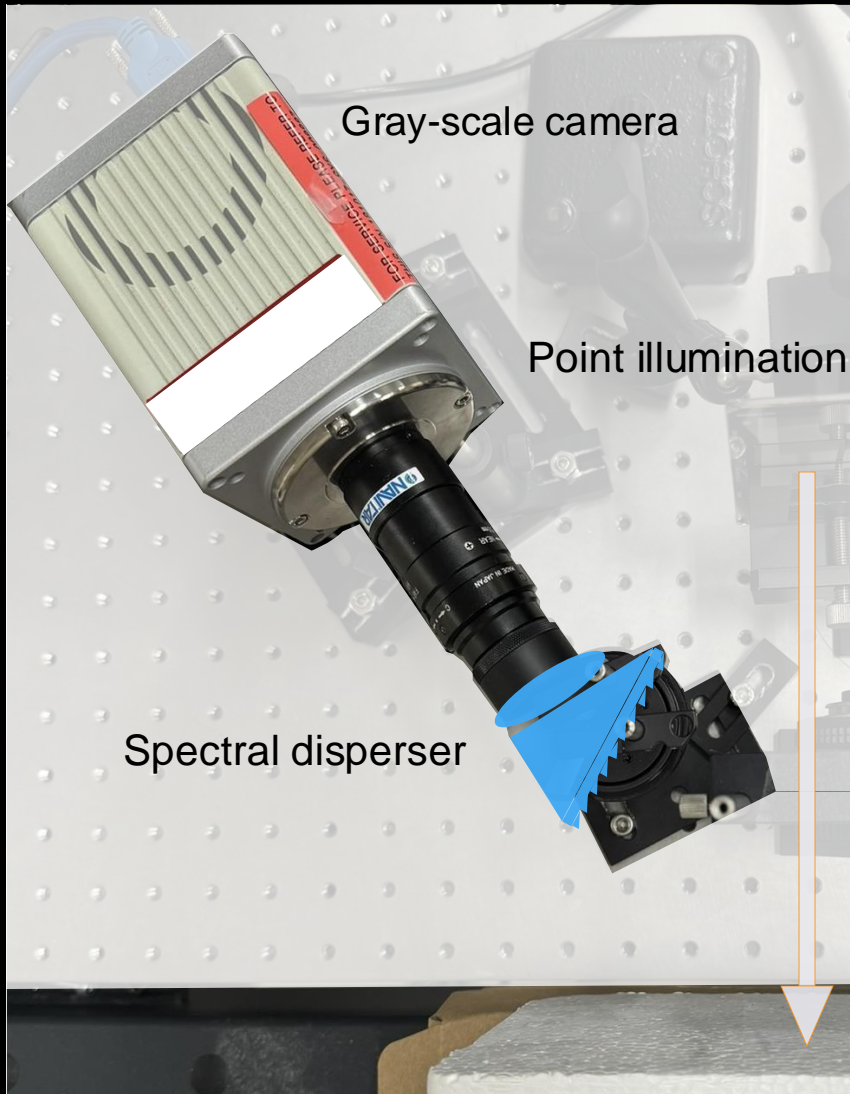

Back et al. (2017 SIGGRAPH),
Cao et al., (2011 IEEE Trans. Pattern Anal.)

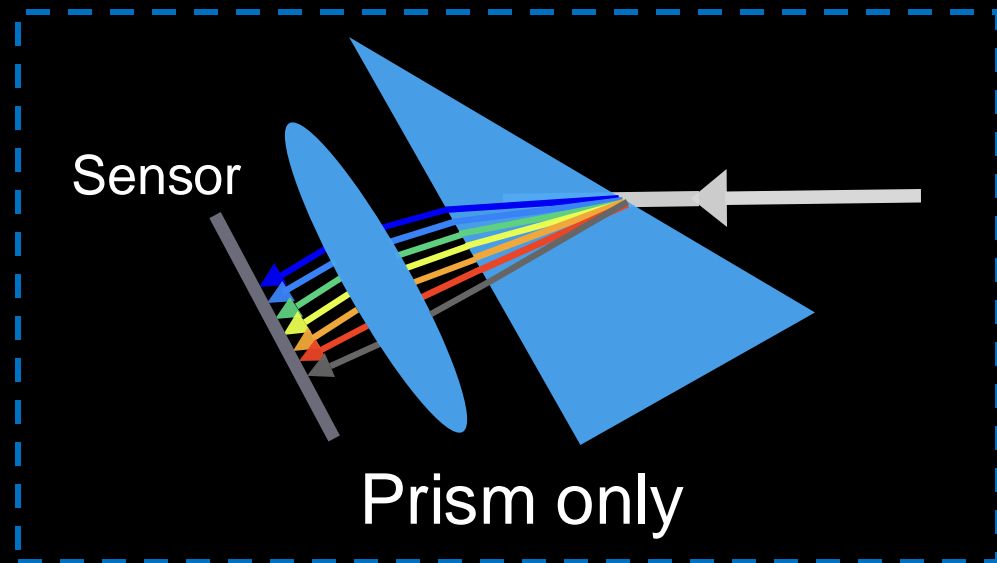

S⁴ Imaging

Single-shot

Motivation Imaging Experiment

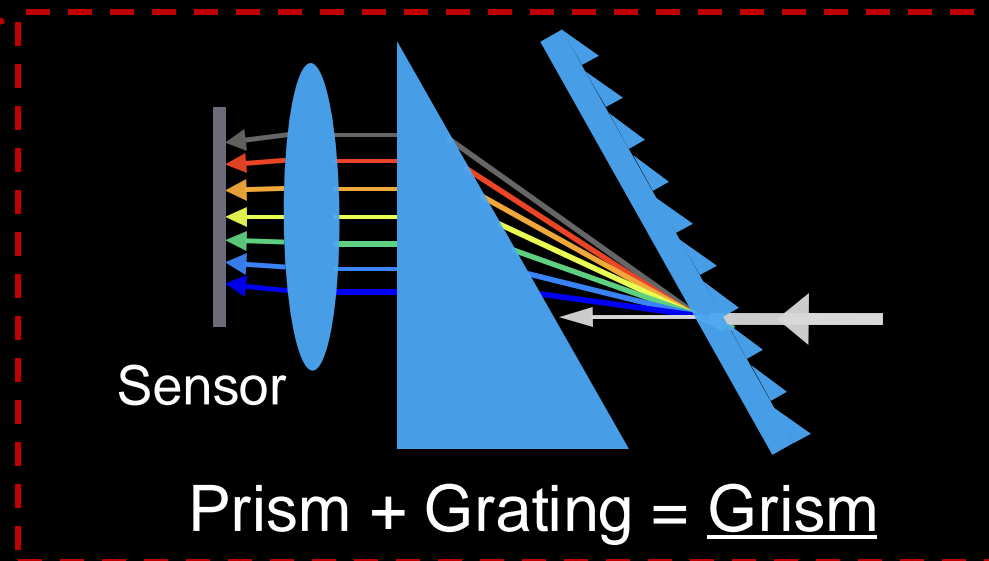
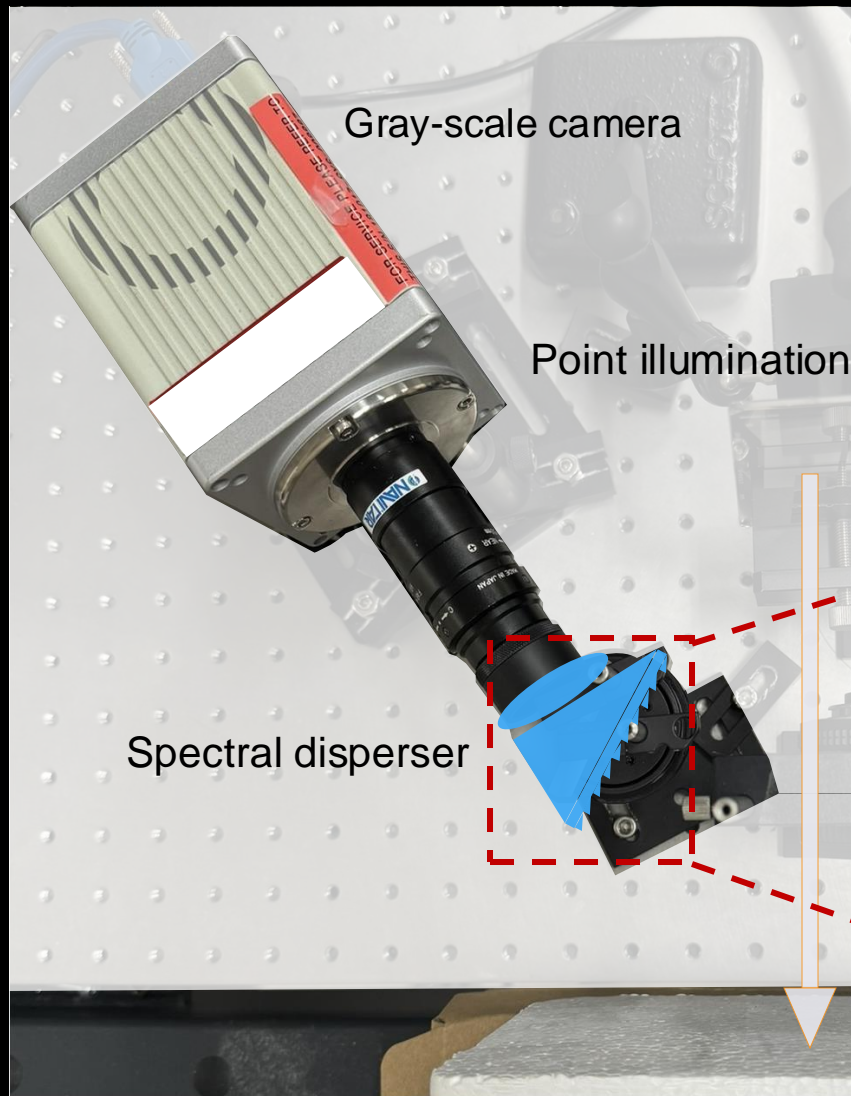

S⁴ Imaging

Single-shot

Motivation Imaging Experiment

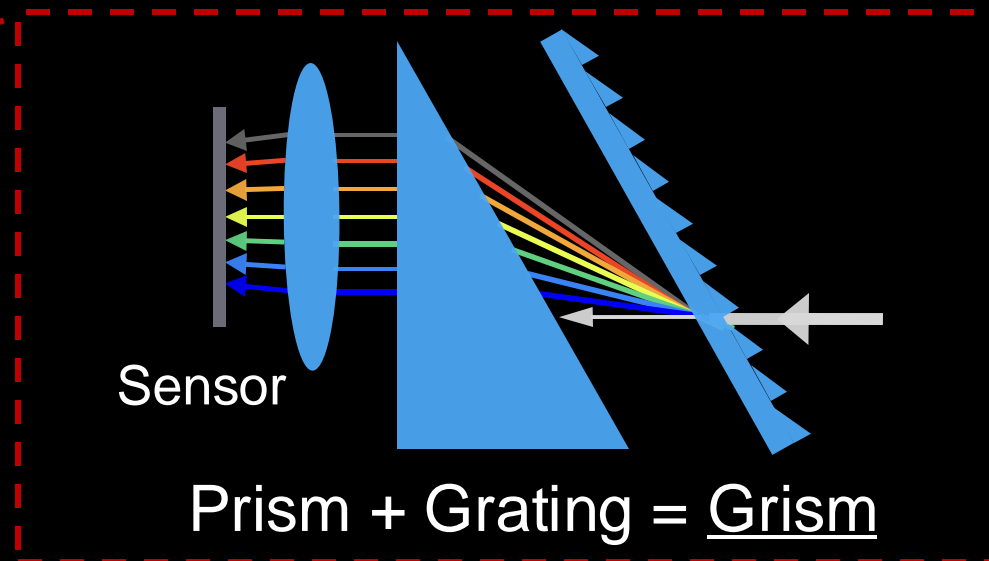
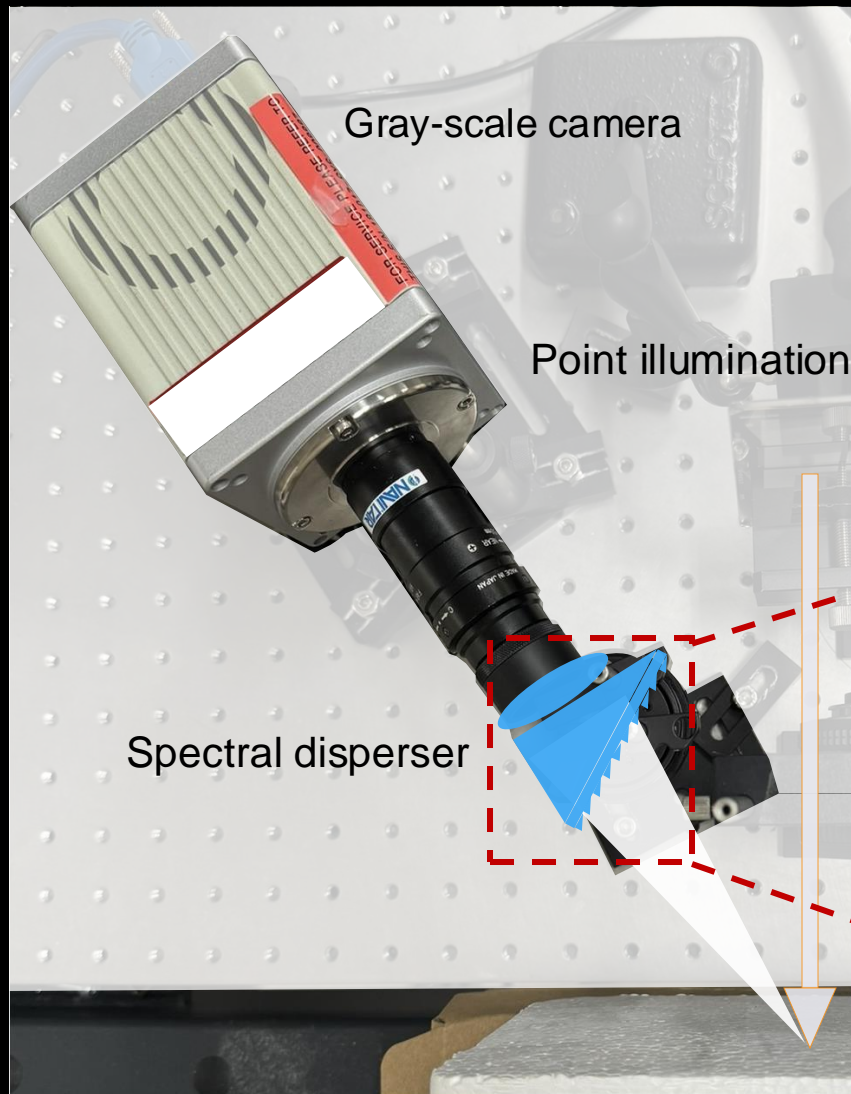

S⁴ Imaging

Single-shot

Motivation Imaging Experiment

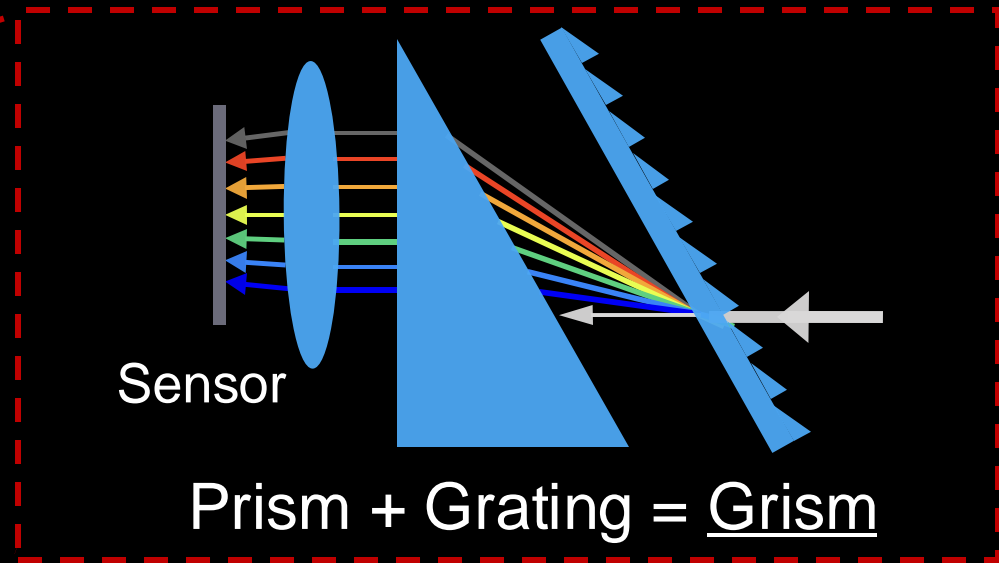
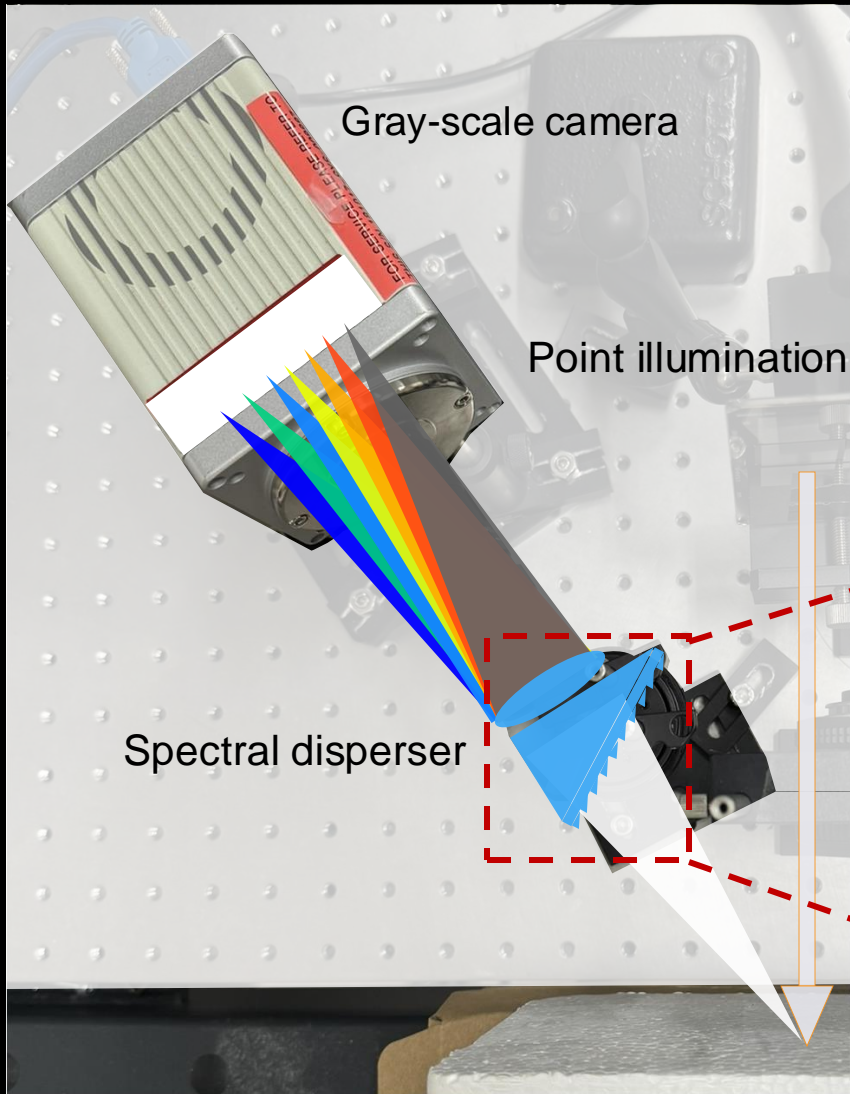

S⁴ Imaging

Single-shot

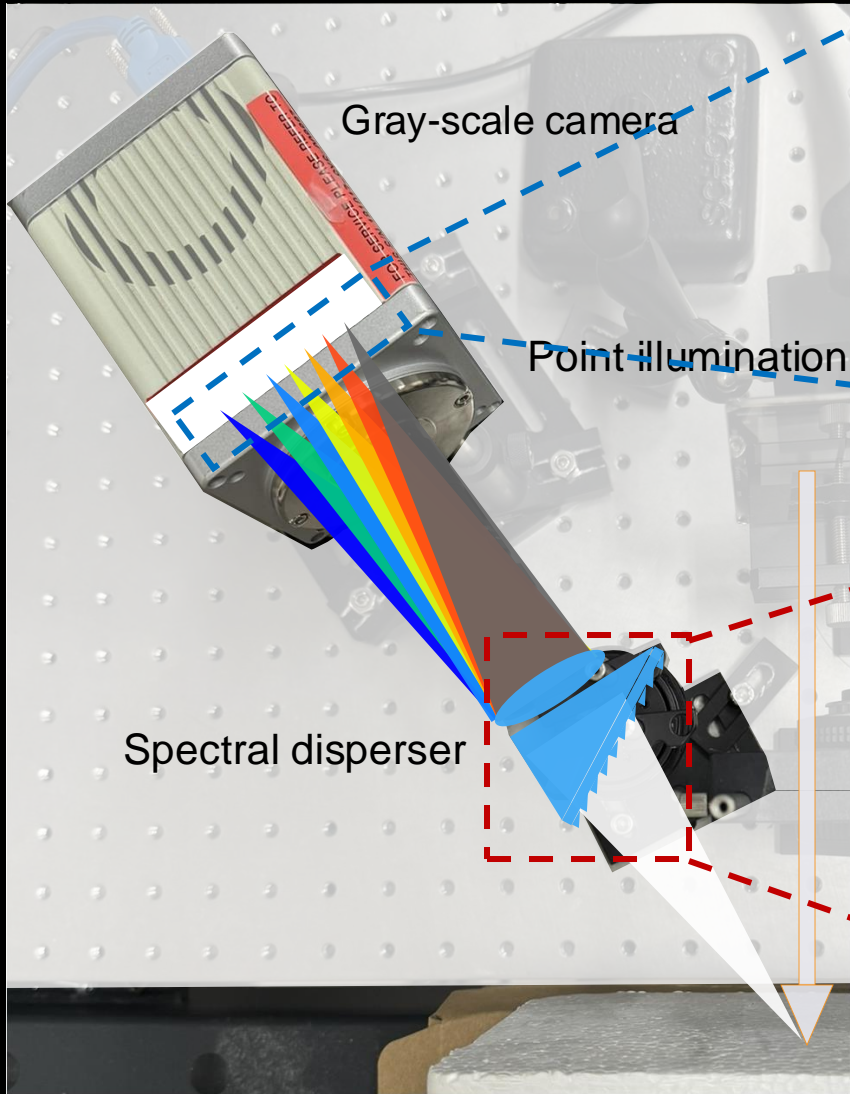

Steel

Wax

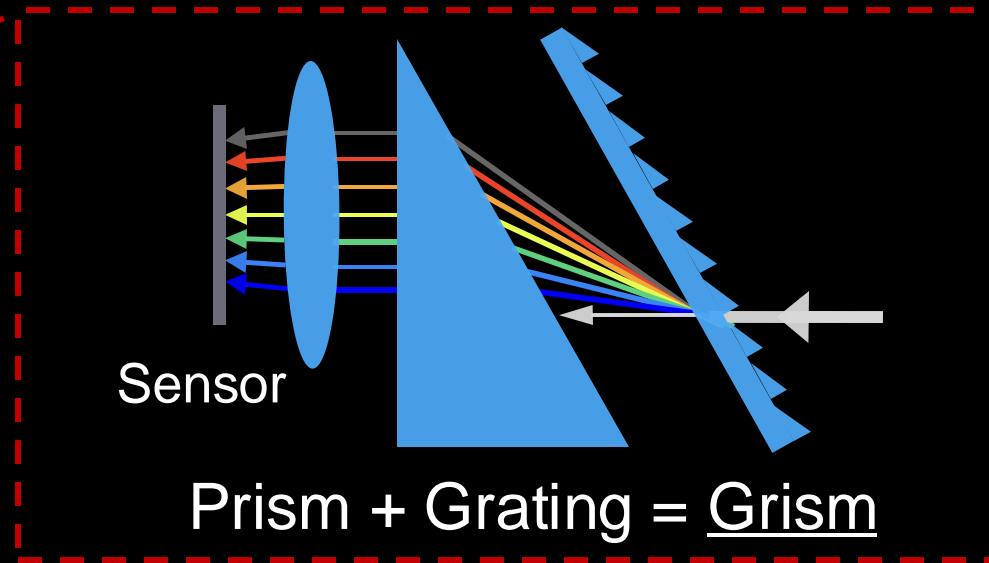
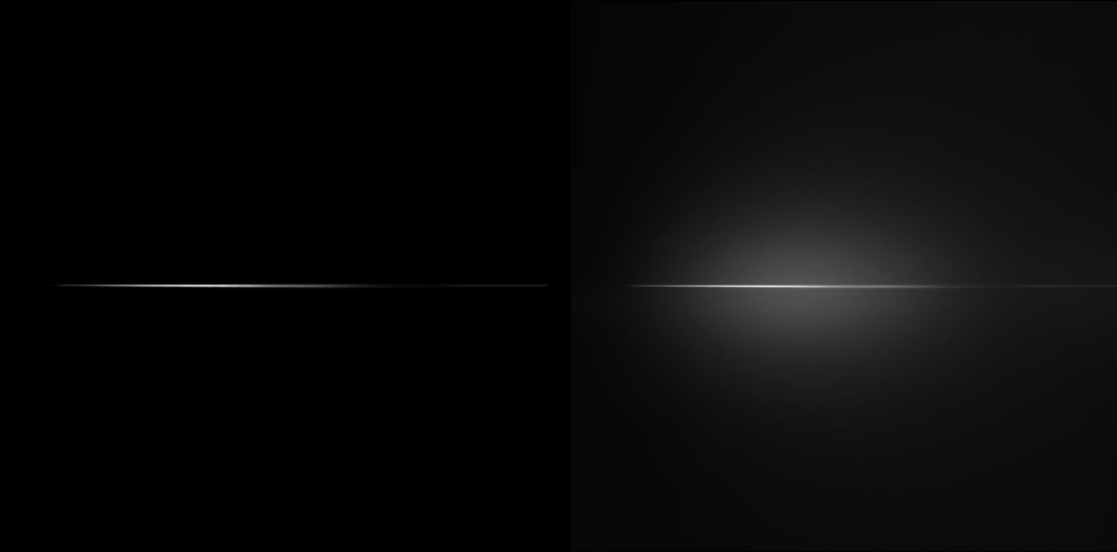

S^4 Imaging

Motivation Imaging Experiment

Multi-shot



S^4 Imaging

Motivation Imaging Experiment

Multi-shot



Projection

Single-shot

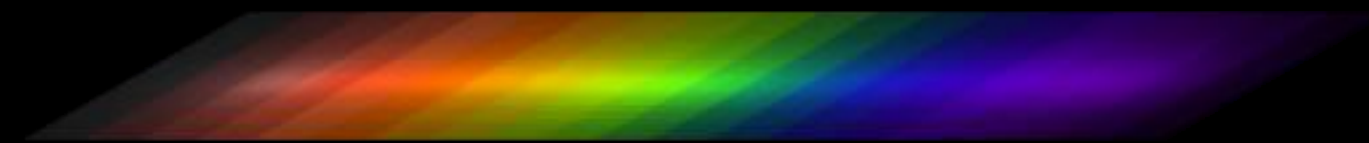

S^4 Imaging

Motivation Imaging Experiment

Multi-shot



Projection

Single-shot

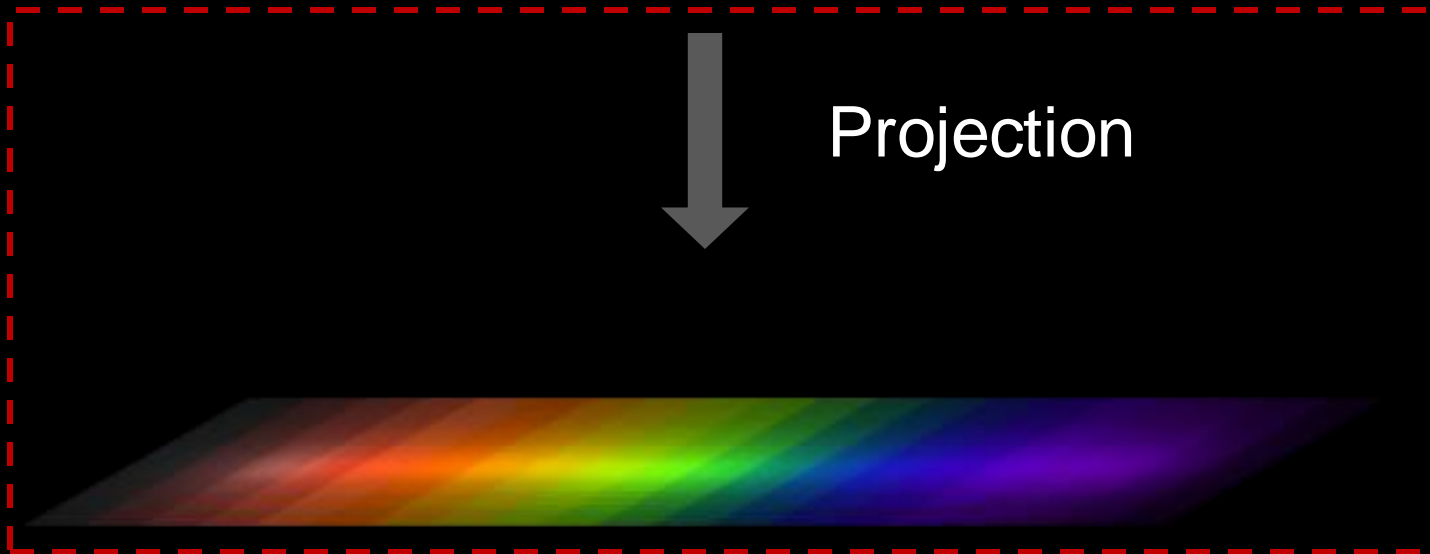

Experiment 1: Justification of Single-shot approach



Experiment 1: Justification of single-shot approach

Motivation Imaging Experiment

Multi-shot



Optimize



Simulation

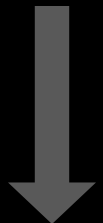

Single-shot

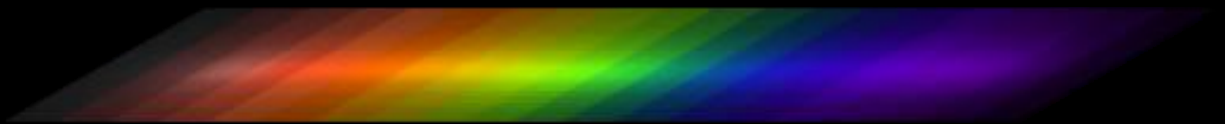

Experiment 1: Justification of single-shot approach

Motivation Imaging Experiment

Multi-shot

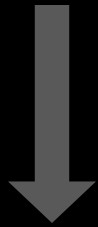

Simulation

Single-shot

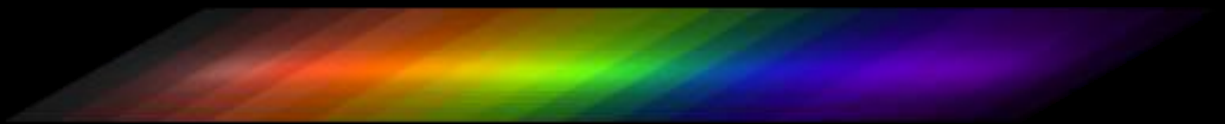

Optimize



Farrell model



Experiment 1: Justification of single-shot approach

Motivation Imaging Experiment

Multi-shot VS Single-shot

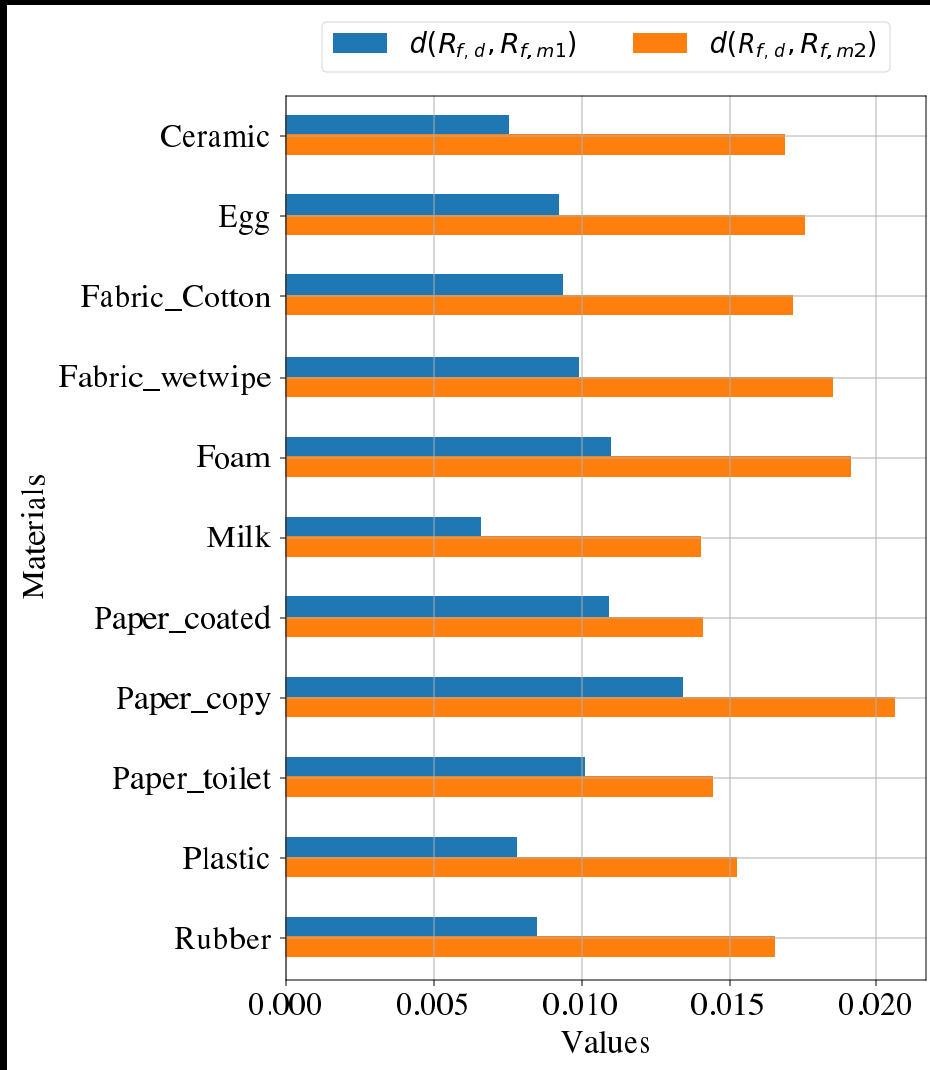

Experiment 1: Justification of single-shot approach

Motivation Imaging Experiment

Multi-shot VS Single-shot

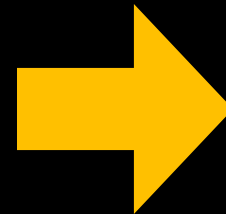
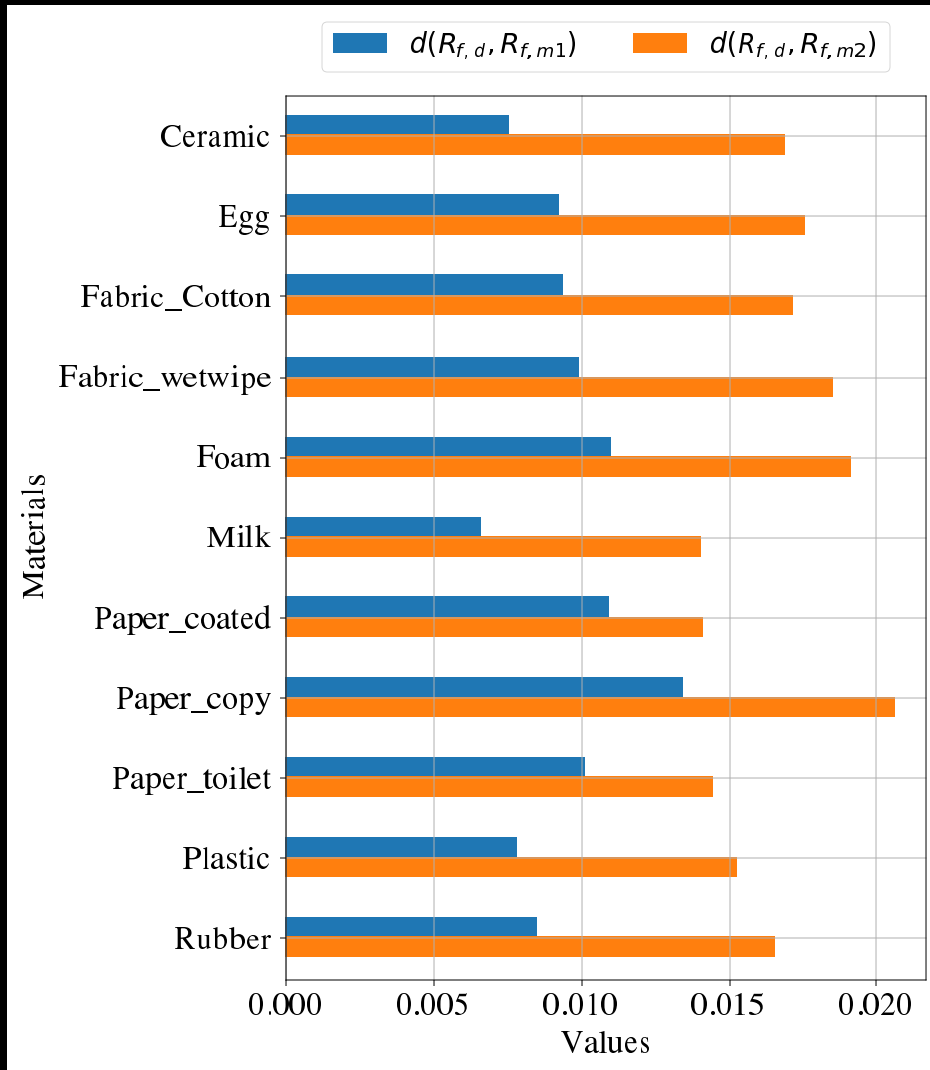

Sufficiently
small gap



Experiment 2: 25-class white material classification

Motivation Imaging Experiment



Experiment 2: 25-class white material classification

Motivation Imaging Experiment

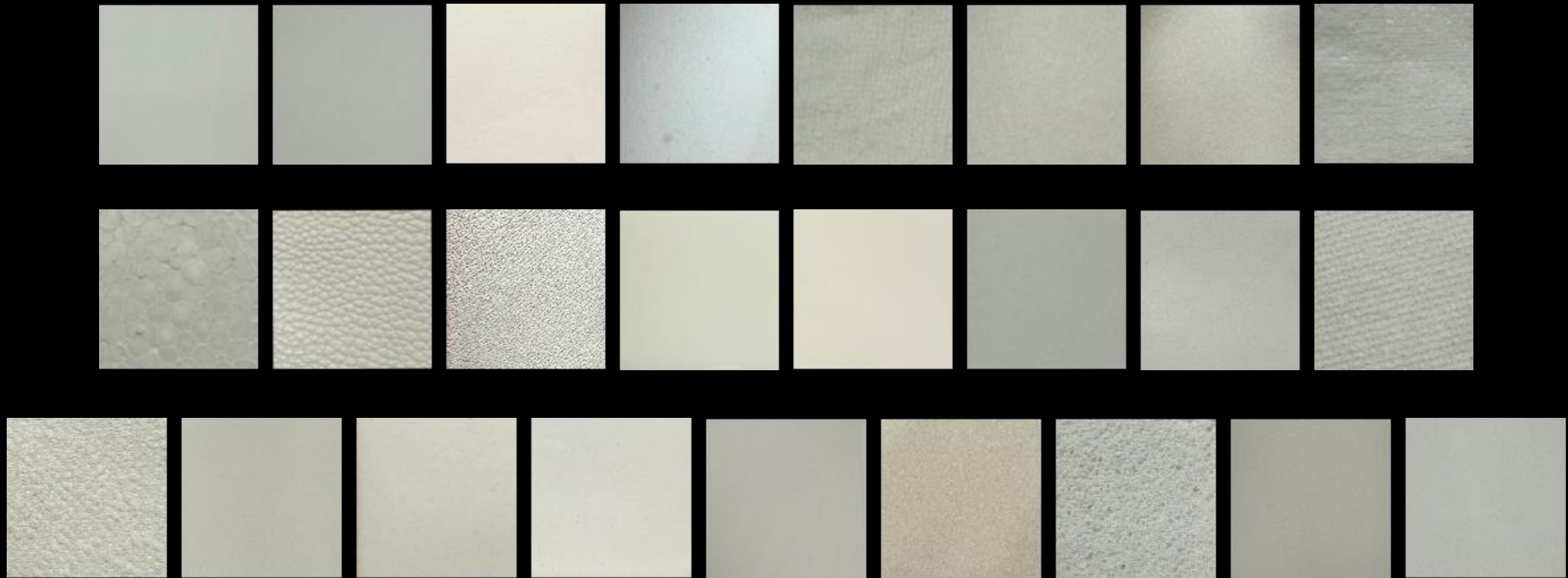

3 objects for each class



Experiment 2: 25-class white material classification

Motivation Imaging Experiment

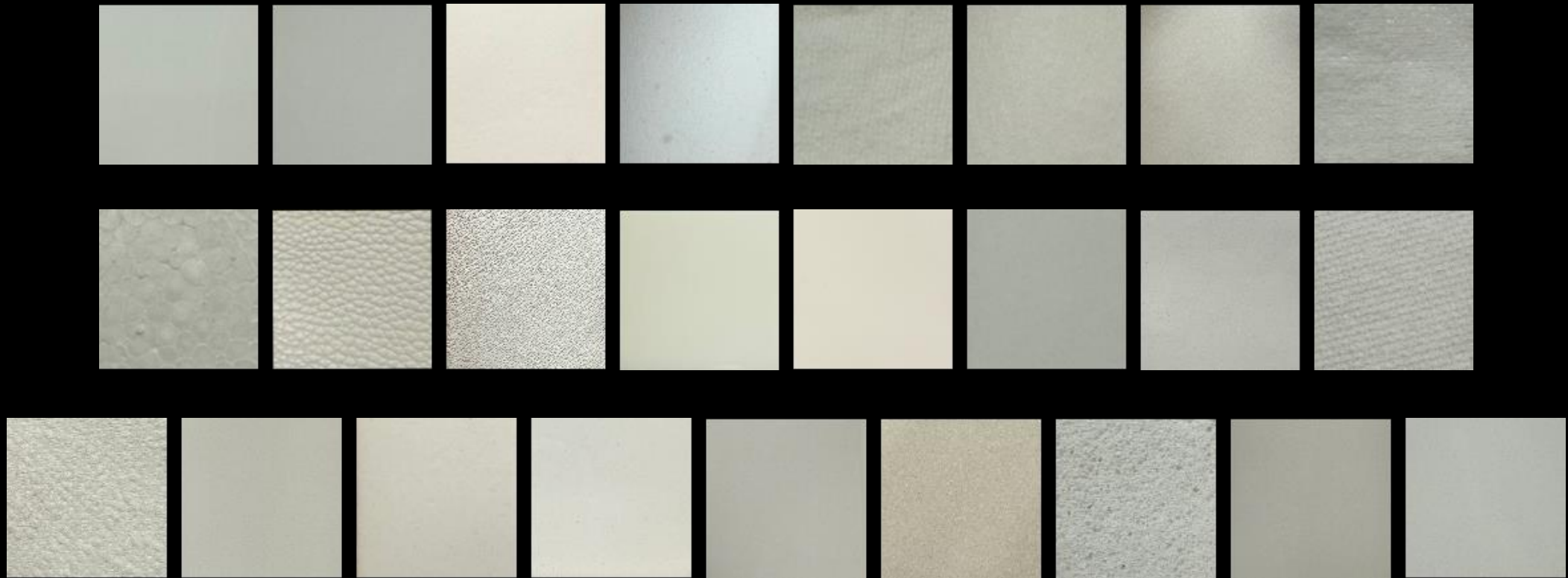

3 objects for each class → 3 folds



Experiment 2: 25-class white material classification

Motivation Imaging Experiment

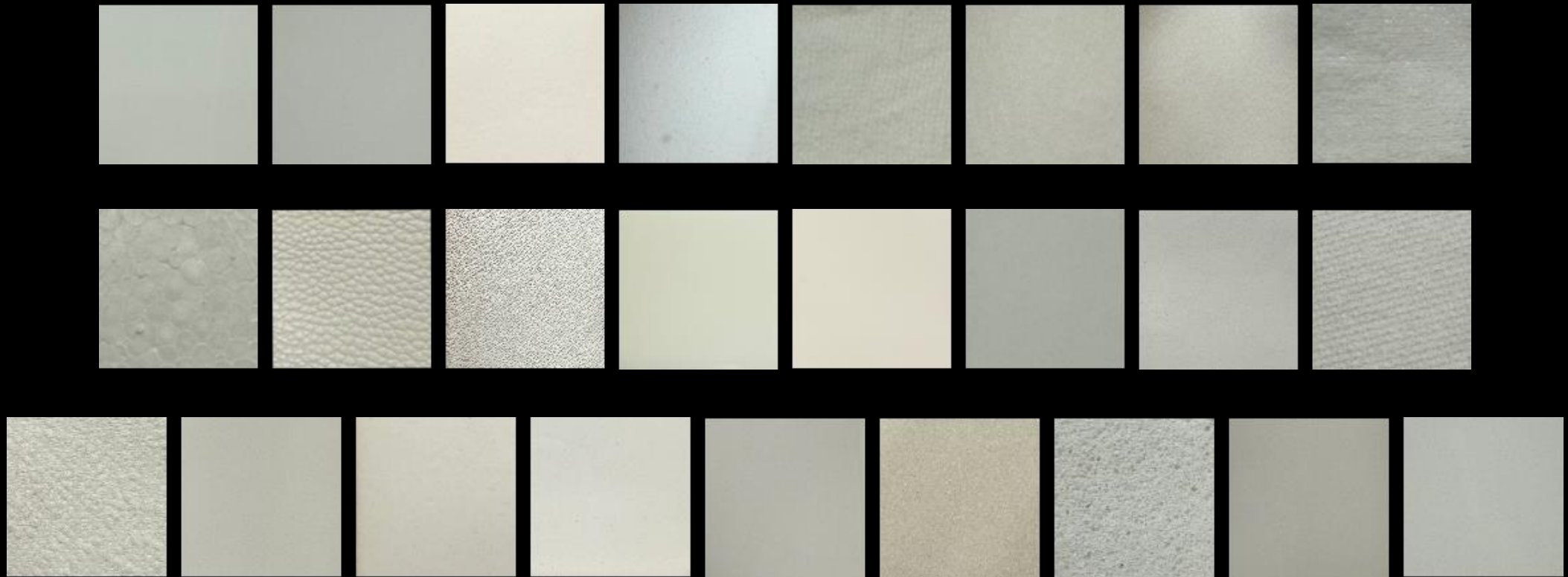

3 objects for each class → 3 folds → 75 objects

Experiment 2: 25-class white material classification

Motivation Imaging Experiment

Table 1: Averaged classification accuracy from 3-fold cross-validation.

	\mathcal{S}^4 (S. Scattering)
SVM	
MLP	
CNN	

S. Scattering: Spectral Sub-Surface Scattering (\mathcal{S}^4).



Experiment 2: 25-class white material classification

Motivation Imaging Experiment

Table 1: Averaged classification accuracy from 3-fold cross-validation.

	\mathcal{S}^2 (S. Reflectance)	\mathcal{S}^4 (S. Scattering)
SVM		
MLP		
CNN		

S. Reflectance: Surface Spectral reflectance (\mathcal{S}^2).

S. Scattering: Spectral Sub-Surface Scattering (\mathcal{S}^4).



Experiment 2: 25-class white material classification

Motivation Imaging Experiment

Table 1: Averaged classification accuracy from 3-fold cross-validation.

	\mathcal{S}^2 (S. Reflectance)	\mathcal{S}^3 (B. Scattering)	\mathcal{S}^4 (S. Scattering)
SVM			
MLP			
CNN			

S. Reflectance: Surface Spectral reflectance (\mathcal{S}^2).
B. Scattering: Broadband Sub-Surface Scattering (\mathcal{S}^3).
S. Scattering: Spectral Sub-Surface Scattering (\mathcal{S}^4).



Experiment 2: 25-class white material classification

Motivation Imaging Experiment

Table 1: Averaged classification accuracy from 3-fold cross-validation.

	\mathcal{S}^2 (S. Reflectance)	\mathcal{S}^3 (B. Scattering)	\mathcal{S}^4 (S. Scattering)
SVM	40.53%	46.93%	52.27%
MLP	<u>41.33%</u>	52.53%	55.20%
CNN	35.47%	<u>53.33%</u>	<u>56.80%</u>

S. Reflectance: Surface Spectral reflectance (\mathcal{S}^2).

B. Scattering: Broadband Sub-Surface Scattering (\mathcal{S}^3).

S. Scattering: Spectral Sub-Surface Scattering (\mathcal{S}^4).



More results and details in the paper



Thank you!

